

LEVITON®

# Stalo & Kristalo®

Catálogo 2024



Para encontrar armonía en tus espacios, los accesorios que elijas siempre deben de combinar con tu decoración.

Los pequeños detalles marcan una gran diferencia y acentúan toda tu decoración, es por esto que **Stalo & Kristalo**® será tu mejor aliado.

**Stalo & Kristalo**® tienen sus raíces del Esperanto, lengua internacional difundida y hablada en más de 120 países, principalmente en Europa, Brasil, China y Asia.

**Stalo**® en Esperanto significa acero y **Kristalo**® significa cristal, tales cualidades que identifican sin lugar a duda a esta nueva línea.



**Stalo & Kristalo®**

*Diseño y elegancia  
en cada detalle*

LEVITON®

# Placas



Residencial - Stalo & Kristalo



Placas Kristalo® cristal templado tipo Decora®



Accesorios Decora®

Blanca

L10-26000-CBD



Accesorios Decora®

Negra

L12-26000-CND



Accesorios Decora®

Dorado

L14-26000-CDD

Placas de Kristalo® cristal templado



Blanca

2 mod ½

L00-26000-CB3



Negro

2 mod ½

L02-26000-CN3



Dorado

2 mod ½

L04-26000-CD3

Placas Stalo® acero



Acero

Accesorios Decora®

L30-28000-DAG



Acero

2 mod ½

L33-28000-02G

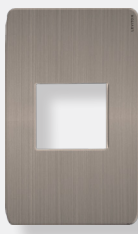

Acero

1 mod ½

L31-28000-01G



Acero Doble

4 mod ½

L53-28000-VDG  
Vertical



Acero Doble

3 mod ½

L34-28000-03G

Horizontal



Acero Doble

4 mod ½

L38-28000-04G

Horizontal

## Placas Stalo® policarbonato blanca



**Blanca**  
**Accesorios Decora®**  
L15-29000-BGF



**Blanca**  
**2 mod ½**  
L12-29000-02B

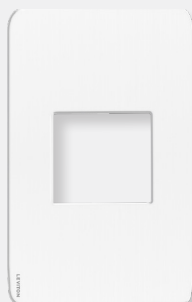

**Blanca**  
**1 mod ½**  
L11-29000-01B



**Blanca**  
**1 mod ½**  
L10-29000-00B

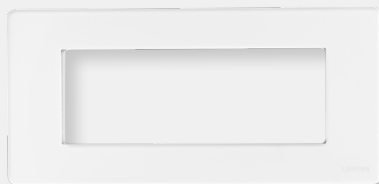

**Blanca**  
**3 mod ½**  
L13-29000-03B  
Horizontal



**Blanca**  
**4 mod ½**  
L14-29000-04B  
Horizontal

## Placas Stalo® policarbonato negro mate



**Negra mate**  
**Accesorios Decora®**  
L45-29000-EGF



**Negra mate**  
**2 mod ½**  
L42-29000-02E



**Negra mate**  
**1 mod ½**  
L41-29000-01E



**Negra mate**  
**1 mod ½**  
L40-29000-00E





## Placas para Exterior

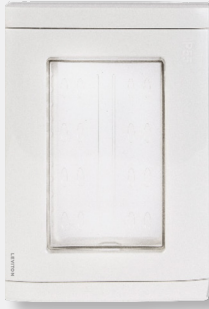

**Blanka**

L00-INTEM-00B



**Negro**

L02-INTEM-00N



# Módulos

Apagadores



**Blanco 3/3**  
Sencillo L30-INTER-33B  
Escalera L30-INTR3-33B



**Negro Mate 3/3**  
Sencillo L32-INTER-33N  
Escalera L32-INTR3-33N



**Acero 3/3**  
Sencillo L33-INTER-33S  
Escalera L33-INTR3-33S

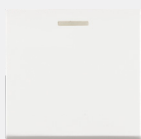

**Blanco 1/2**  
Sencillo L20-INTER-12B  
Escalera L20-INTR3-12B  
4 Vías L20-INTR4-12B



**Negro Mate 1/2**  
Sencillo L22-INTER-12N  
Escalera L22-INTR3-12N  
4 Vías L22-INTR4-12N



**Acero 1/2**  
Sencillo L23-INTER-12S  
Escalera L23-INTR3-12S

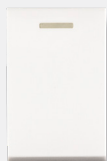

**Blanco 1/3**  
Sencillo L10-INTER-13B  
Escalera L10-INTR3-13B  
4 Vías L10-INTR4-13B



**Negro Mate 1/3**  
Sencillo L12-INTER-13N  
Escalera L12-INTR3-13N  
4 Vías L12-INTR4-13N

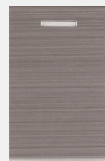

**Acero 1/3**  
Sencillo L13-INTER-13S  
Escalera L13-INTR3-13S



**Blanco 1/2**  
Sencillo L40-INTER-D2B  
Escalera L40-INTR3-D2B



**Negro Mate 1/2**  
Sencillo L42-INTER-ODN  
Escalera L42-INTR3-ODN



**Acero 1/2**  
Sencillo L43-INTER-ODS  
Escalera L43-INTR3-ODS



⚡ Receptáculos



**Blanco 1/3**  
L10-LTOMA-13B



**Negro Mate 1/3**  
L12-LTOMA-13N



**Blanco 3/3**  
L30-LTOMA-33B



**Negro Mate 3/3**  
L32-LTOMA-33N

Receptáculo euroamericano

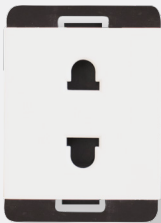

**Blanco**  
L20-2PINS-12B



**Negro**  
L22-2PINS-12N



**Blanco**  
L50-EUROA-23B



**Negro**  
L52-EUROA-23N

⚡ Receptáculo schuko



**Blanco**  
L50-SHUKO-23B



**Negro**  
L52-SHUKO-23N

 Pulsadores



**Blanco 3/3**

L30-PULSA-33B



**Negro Mate 3/3**

L32-PULSA-33N



**Acero 3/3**

L33-PULSA-33S



**Blanco 1/2**

L20-PULSA-12B



**Negro Mate 1/2**

L22-PULSA-12N



**Acero 1/2**

L23-PULSA-12S



**Blanco 1/3**

L10-PULSA-13B



**Negro Mate 1/3**

L12-PULSA-13N

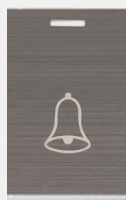

**Acero 1/3**

L13-PULSA-13S

 Timbres



**Blanco 2/3**

L50-MODUL-23B



**Negro Mate 2/3**

L52-MODUL-23N



 **USB Sencillo**

 **USB Doble**



**Blanco 1/3**  
L10-1USBL-13B



**Negro Mate 1/3**  
L12-1USBL-13N

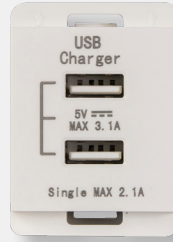

**Blanco 1/2**  
L20-2USBL-12B

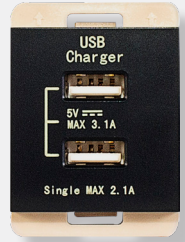

**Negro Mate 1/2**  
L22-2USBL-12N

 **Video**

 **Teléfono**



**Blanco 1/3**  
L10-HDMIL-13B



**Negro Mate 1/3**  
L12-HDMIL-13N



**Blanco 1/2**  
L20-LRJ11-12B



**Negro Mate 1/2**  
L22-LRJ11-12N

 **Internet**



**Blanco 1/2**  
L20-LRJ45-12B



**Negro Mate 1/2**  
L22-LRJ45-12N

Otros

 Ciegos



**Blanco 1/6**

L60-MDULO-16B



**Negro Mate 1/6**

L62-MDULO-16N

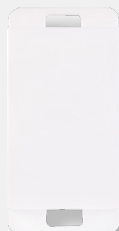

**Blanco 1/3**

L10-MDULO-13B

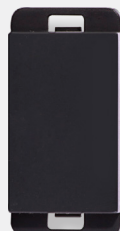

**Negro Mate 1/3**

L12-MDULO-13N



**Blanco 1/2**

L20-MDULO-12B



**Negro Mate 1/2**

L22-MDULO-12N

 RCA



**Blanco**

L50-0LRCA-23B



**Negro**

L52-0LRCA-23N





### Sensor de presencia



**Blanco**

L50-INFRA-23B



**Negro**

L52-INFRA-23N



### Control de ventilador



**Blanco**

L30-LVENT-33B



**Negro**

L32-LVENT-33N



### Interruptor de tarjeta



**Blanco**

L30-KEYCD-33B



**Negro**

L32-KEYCD-33N



### Coaxial

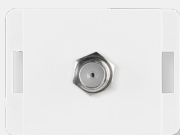

**Blanco 1/2**

L20-TVCAx-12B



**Negro Mate 1/2**

L22-TVCAx-12N

# Especificaciones técnicas

## Chasis de acero



**3 módulos 1/3  
o 2 módulos 1/2**

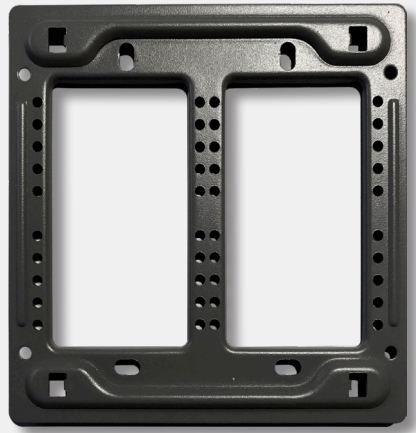

**6 módulos 1/3  
o 4 módulos 1/2**



**Placas 3 Mod 1/3**  
L92-CHALU-002

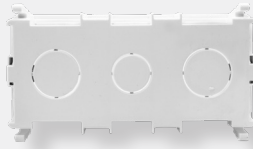

**Placas 3 Mod 1/2**  
L93-CHALU-003



**Placa 6 Mod 1/3**  
L94-CHALU-004

## Tamaños de Placas



**3 módulos 1/3  
o 2 módulos 1/2**



**1 módulo 1/2**



**6 módulos 1/3  
o 4 módulos 1/2**



## Tamaños de Placas

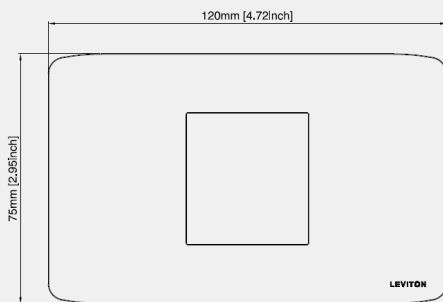

**1 módulo 1/2**

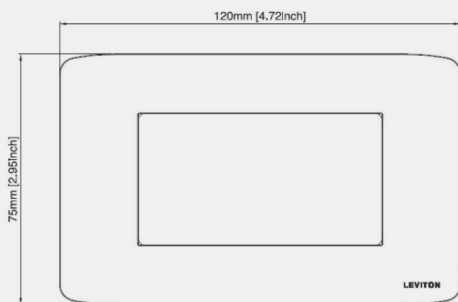

**3 módulos 1/3  
o 2 módulos 1/2**

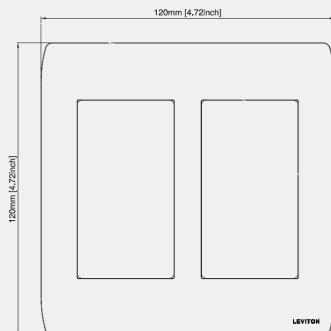

**6 módulos 1/3  
o 4 módulos 1/2**



**L34-28000-03G**  
**L13-29000-03B**

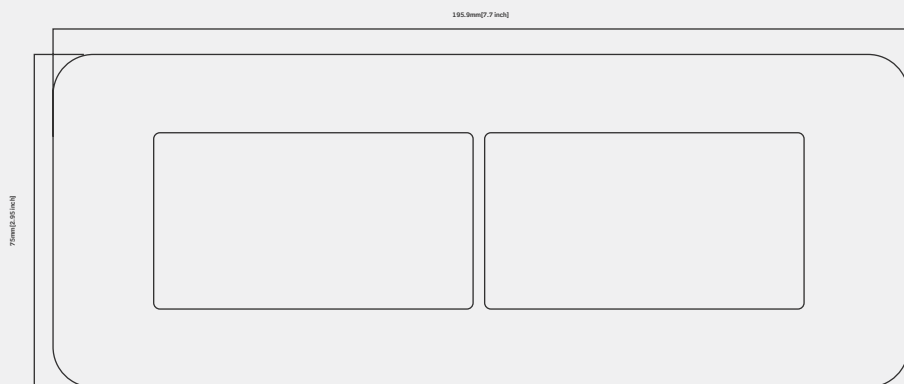

**L38-28000-04G**  
**L14-29000-04B**

# Módulos

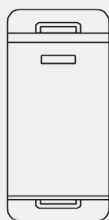

**1/3**

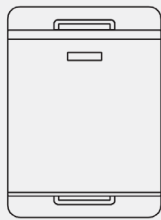
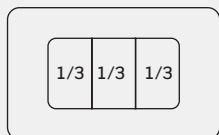

**1/2**

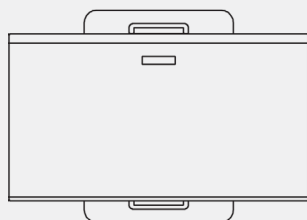
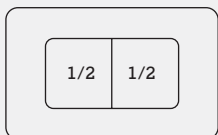

**3/3**

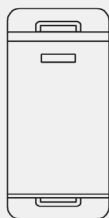
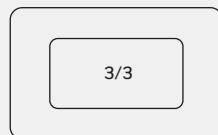

**1/3**

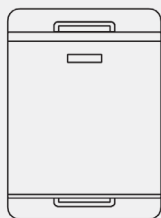
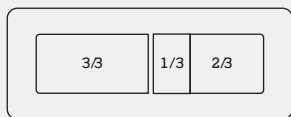

**1/2**

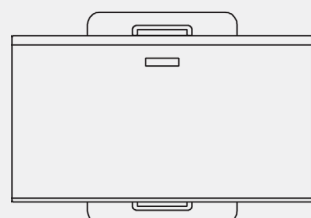
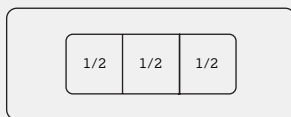

**3/3**

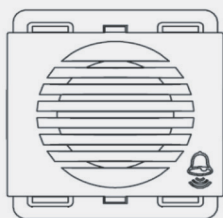
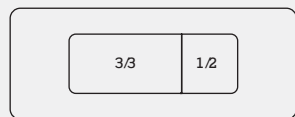

**2/3**

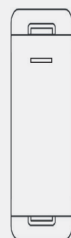
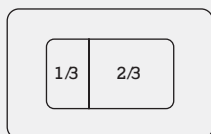

**1/6**

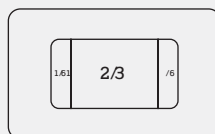



**Stalo & Kristalo®**

*El lenguaje que todos hablarán.*



**LEVITON®**



**Leviton México**

Santa Fe 94 Torre A Piso 8,  
Col. Zedec Santa Fe,  
Alc. Álvaro Obregón,  
Ciudad de México

Tel. (55) 5081 2270

[www.leviton.com/es](http://www.leviton.com/es)



LevitonMexicoOficial