



Iluminación

ARGOS 

Iluminación

ILUMINACIÓN

Lámpara halógena dicroica MR-16

Código	W	V	Hz	Base	Bulbo	Ángulo	lm	Vida (horas)	Piezas
9400850	50	12	60	GU5.3	MR-16	36	800	2 000	10

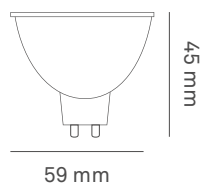

Lámpara fluorescente compacta autobalastada espiral T3

Código	W	V	Hz	K	Dimensiones AxB (mm)	Base	Bulbo	lm	Vida (horas)	Piezas
8900010	11	127	60	6 400	55x137	E-26	T3	556	8 000	50

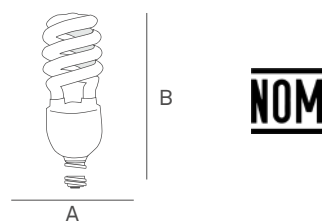

Lámpara PLC de LED

Código	W	V	Hz	K	lm	Piezas
9403243	11	127-277	60	4 100	1 150	1



Lámpara de LED

Código	W	V	Hz	K	lm	Piezas
9403016	9	127	60	3 000	810	100
9403017	9	127	60	6 500	810	100
9403018	12	127	60	3 000	1 050	100
9403019	12	127	60	6 500	1 050	100



Lámpara de LED

Código	W	V	Hz	K	Dimensiones	Base	Bulbo	lm	Vida	Piezas
					AxB (mm)					
9403040	16	127-240	60	6 500	80x154	E-27	A-80	1 800	30 000	1
9403042	20	127-240	60	6 500	95x168	E-27	A-95	2 300	30 000	1
9403048	55	127-240	60	6 500	160x275	E-27	A-160	6 000	30 000	1

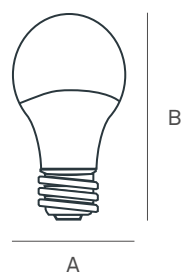

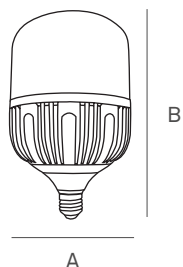

Lámpara de LED

Código	W	V	Hz	K	Dimensiones	Base	Bulbo	lm	Vida	Piezas
					AxB (mm)				(horas)	
9403044	36	127-240	60	6 500	202x120	E-27	T-120	4 000	30 000	1
9403046	45	127-240	60	6 500	232x140	E-27	T-140	5 000	30 000	1



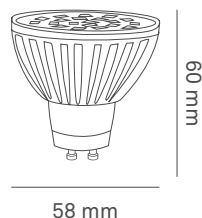

Lámpara MR16 GU10 de LED de colores

Código	Color	W	V	Hz	K	Base	Bulbo	lm	Vida	Piezas
									(horas)	
9403364		2.3	100-127	60	3 000	GU10	MR16	130	25 000	100
9403365		2.3	100-127	60	3 000	GU10	MR16	130	25 000	100



Lámpara JDR de LED de colores

Código	Color	W	V	Hz	Base	Bulbo	lm	Vida	Piezas
								(horas)	
9403373		2.3	100-127	60	E-26	JDR	130	25 000	100
9403374		2.3	100-127	60	E-26	JDR	130	25 000	100
9403375		2.3	100-127	60	E-26	JDR	130	25 000	100

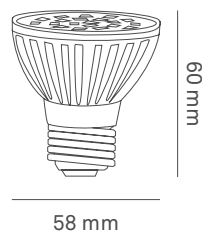

Lámpara lineal de LED (Tubo T5)

Código	W	V	Hz	K	Longitud (mm)	Base	Bulbo	lm	Vida (horas)	Piezas
9403280	9	110-277	50/60	4 100	560	G5	T5	900	30 000	1
9403284	18	110-277	50/60	4 100	1 160	G5	T5	1 800	30 000	1

- Incluye driver externo.



Manguera plana de LED

Código	W	V	Hz	K	Longitud (m)	Grado de protección	lm	Vida (horas)	Piezas
9403203	38	127	60	3 000	5	IP-65	6 000	50 000	1
9403207	38	127	60	6 000	5	IP-65	6 000	50 000	1

- 60 leds por metro.
- Incluye driver.



Driver para manguera plana de LED

Código	W	V	Hz	Piezas
9403210	38	127	60	1





Carcasa circular de empotrar dirigible MR16 blanco

Código	Cuerpo	Terminado	Aplicaciones	Tipo de lámpara	Lámpara incluida	Base	Piezas
A1D-0S3S0-G-B1/00	Aluminio	Blanco	Empotrar en techo	MR16	No	GU10	1

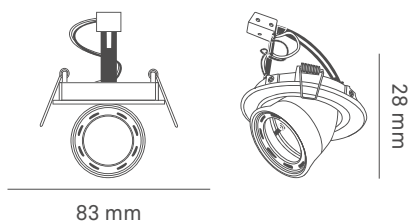

Carcasa circular de empotrar fijo MR16 blanco

Código	Cuerpo	Terminado	Aplicaciones	Tipo de lámpara	Lámpara incluida	Base	Piezas
A1F-0S3S0-G-B2/00	Aluminio	Blanco	Empotrar en techo	MR16	No	GU10	1

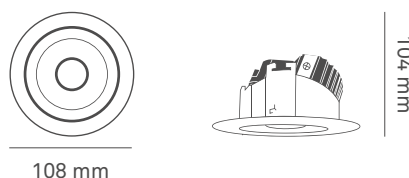

Carcasa cuadrada de empotrar fijo MR16 blanco

Código	Cuerpo	Terminado	Aplicaciones	Tipo de lámpara	Lámpara incluida	Base	Piezas
A1F-0S14S0-G-B5/00	Aluminio	Blanco	Empotrar en techo	MR16	No	GU10	1

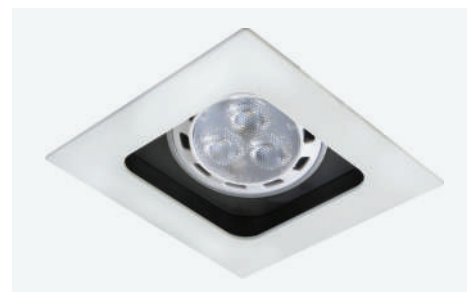
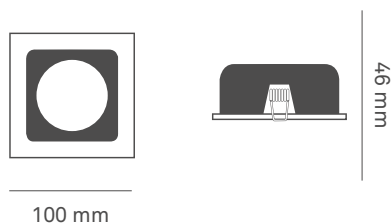

Carcasa cuadrada de empotrar fijo MR16 gris

Código	Cuerpo	Terminado	Aplicaciones	Tipo de lámpara	lámpara incluida	Base	Piezas
A1F-0S3S0-G-G5/00	Aluminio	Gris	Empotrar en techo	MR16	No	GU10	1



90 mm



145 mm

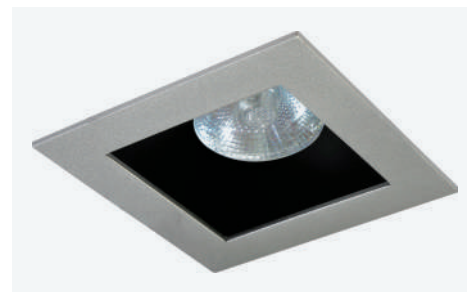

Carcasa cuadrada de empotrar fijo MR16 blanco

Código	Cuerpo	Terminado	Aplicaciones	Tipo de lámpara	Lámpara incluida	Base	Piezas
A1F-0S3S0-G-B4/00	Aluminio	Blanco	Empotrar en techo	MR16	No	GU10	1

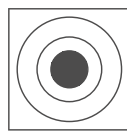

120 mm

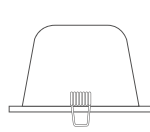

105 mm





Carcasa cuadrada de empotrar 1, 2, 3 y 4 salidas GU10 blanco

Código	Cuerpo	Terminado	Aplicaciones	Tipo de lámpara	Lámpara incluida	Base	Piezas
A1F-0S7S0-G-B3/00	Aluminio	Blanco	Empotrar en techo	MR16	No	GU10	1
A1F-0S7S0-G-B3/02	Aluminio	Blanco	Empotrar en techo	MR16	No	GU10	1
A1F-0S7S0-G-B3/03	Aluminio	Blanco	Empotrar en techo	MR16	No	GU10	1
A1F-0S7S0-G-B3/04	Aluminio	Blanco	Empotrar en techo	MR16	No	GU10	1

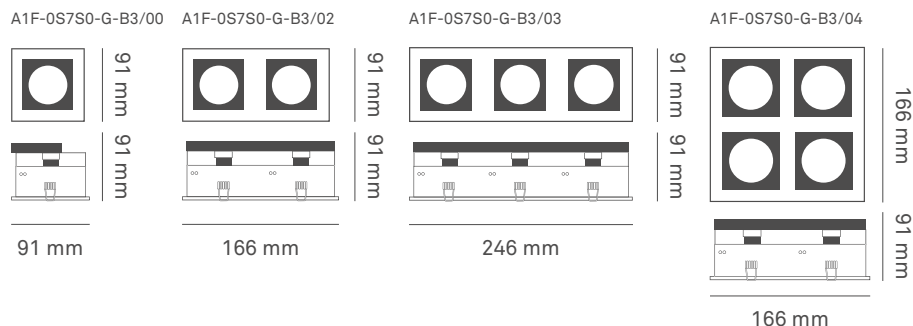

Carcasa cuadrada de empotrar dirigida 1, 2 y 3 salidas AR111 negro

Código	Cuerpo	Terminado	Aplicaciones	Tipo de lámpara	Lámpara incluida	Base	Piezas
A1D-0S12S0-G-N3/00	Aluminio	Negro	Empotrar en techo	AR111	No	G53	1
A1D-0S12S0-G-N3/02	Aluminio	Negro	Empotrar en techo	AR111	No	G53	1
A1D-0S12S0-G-N3/03	Aluminio	Negro	Empotrar en techo	AR111	No	G53	1

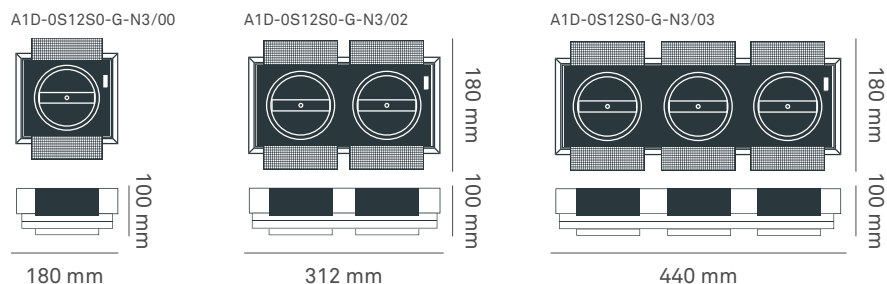

Carcasa de suspender 2, 3 y 4 lámparas AR11 blanco

Código	Cuerpo	Terminado	Aplicaciones	Tipo de lámpara	Lámpara incluida	Base	Piezas
A3M-0S12S0-G-G6/00	Aluminio	Blanco	Suspender en techo	AR11	No	G53	1
A3M-0S12S0-G-G6/01	Aluminio	Blanco	Suspender en techo	AR11	No	G53	1
A3M-0S12S0-G-G6/02	Aluminio	Blanco	Suspender en techo	AR11	No	G53	1

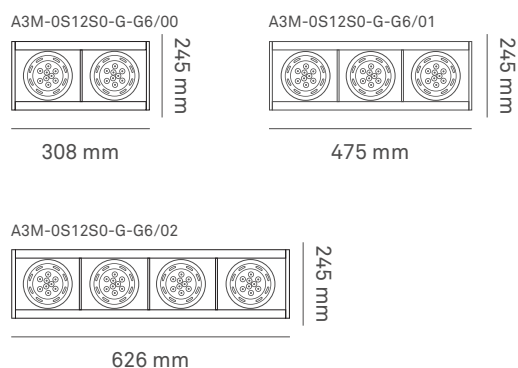

Carcasa cuadrada de empotrar dirigida 1, 2, 3 y 4 salidas CDMT gris

Código	Cuerpo	Terminado	Aplicaciones	Tipo de lámpara	Lámpara incluida	Base	Piezas
A1D-0S4S0-G-G3/00	Aluminio	Gris	Empotrar en techo	CDMT	No	G12	1
A1D-0S4S0-G-G3/02	Aluminio	Gris	Empotrar en techo	CDMT	No	G12	1
A1D-0S4S0-G-G3/03	Aluminio	Gris	Empotrar en techo	CDMT	No	G12	1
A1D-0S4S0-G-G3/04	Aluminio	Gris	Empotrar en techo	CDMT	No	G12	1

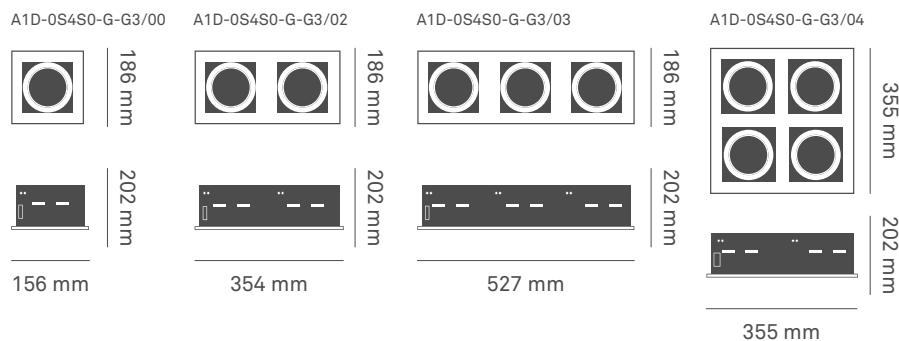



Carcasa cuadrada de empotrar fijo 1 lámpara HQI 70 W blanco

Código	Cuerpo	Terminado	Aplicaciones	Tipo de lámpara	Lámpara incluida	Base	Piezas
A1F-0S15S0-G-B3/01	Aluminio	Blanco	Empotrar en techo	HQI	No	RX75	1

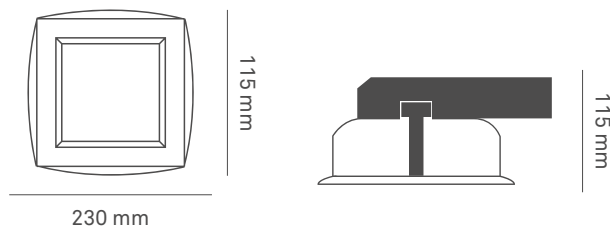

Carcasa esférica de sobreponer dirigible AR111 blanco

Código	Cuerpo	Terminado	Aplicaciones	Tipo de lámpara	Lámpara incluida	Base	Piezas
A4F-0S12S0-G-B8/00	Aluminio	Blanco	Sobreponer en techo	AR111	No	G53	1

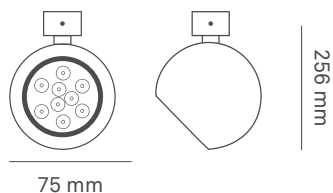

Carcasa de empotrar a muro halógena G9 blanco

Código	Cuerpo	Terminado	Aplicaciones	Tipo de lámpara	Lámpara incluida	Base	Piezas
A5M-0S6S0-8-B0/00	Aluminio	Blanco	Empotrar a muro	Halógena	No	G9	1

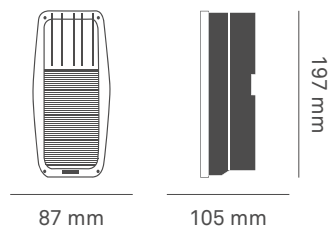

Carcasa para sobreponer en riel PAR blanco

Código	Cuerpo	Terminado	Aplicaciones	Tipo de lámpara	Lámpara incluida	Base	Piezas
A7M-0S1S0-G-B0/00	Aluminio	Blanco	Sobreponer a riel	PAR20	No	E-26	1
A7M-0S1S0-G-B0/01	Aluminio	Blanco	Sobreponer a riel	PAR30	No	E-26	1
A7M-0S1S0-G-B0/02	Aluminio	Blanco	Sobreponer a riel	PAR38	No	E-26	1

A7M-0S1S0-G-B0/01

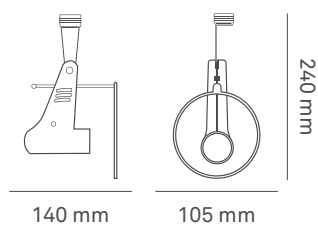

A7M-0S1S0-G-B0/02

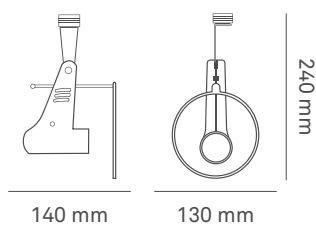

Luminario cuadrado de empotrar VR de LED con 2 lámparas PLC blanco

Código	W	V	Hz	K	Base	Ángulo	lm	Piezas
A1F-2L9S41-F-B4/111	22	120-277	50/60	4 100	G24q3	75°-45°	2 300	1

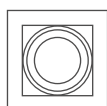
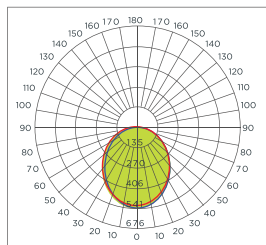

240 mm

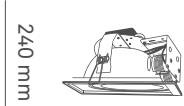

152 mm

240 mm



Carcasa

Código	Cuerpo	Terminado	Aplicaciones	Tipo de lámpara	Lámpara incluida	Base	Piezas
A1F-0S9S0-G-B4/01	Aluminio	Blanco	Empotrar en techo	PLC	No	G24q3	1

Luminario cuadrado de empotrar VC de LED con 2 lámparas PLC blanco

Código	W	V	Hz	K	Base	Ángulo	lm	Piezas
A1F-2L9S41-F-B3/111	22	120-277	50/60	4 100	G24q3	75°	2 300	1

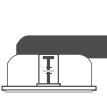
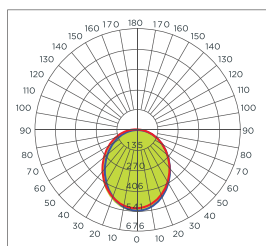

230 mm



230 mm

230 mm



Carcasa

Código	Cuerpo	Terminado	Aplicaciones	Tipo de lámpara	Lámpara incluida	Base	Piezas
A1F-0S9S0-G-B3/01	Aluminio	Blanco	Empotrar en techo	PLC	No	G24q3	1

Luminario cuadrado de empotrar CU de LED con 2 lámparas PLC blanco

Código	W	V	Hz	K	Base	Ángulo	lm	Piezas
A1F-2L9S41-F-B3/112	22	120-277	50/60	4 100	G24q3	75°	2 300	1

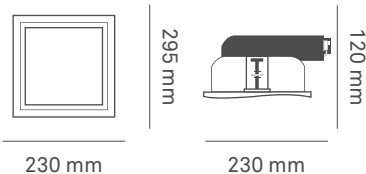
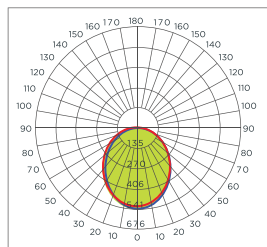

Carcasa

Código	Cuerpo	Terminado	Aplicaciones	Tipo de lámpara	Lámpara incluida	Base	Piezas
A1F-0S9S0-G-B3/02	Aluminio	Blanco	Empotrar en techo	PLC	No	G24q3	1

Luminario cuadrado de empotrar RA de LED con 2 lámparas PLC blanco

Código	W	V	Hz	K	Base	Ángulo	lm	Piezas
A1F-2L9S41-F-B5/111	22	120-277	50/60	4 100	G24q3	60°	2 300	1

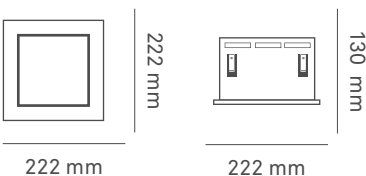
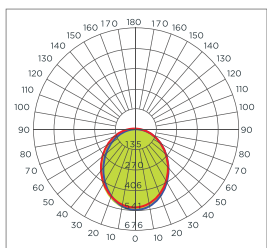

Carcasa

Código	Cuerpo	Terminado	Aplicaciones	Tipo de lámpara	Lámpara incluida	Base	Piezas
A1F-0S9S0-G-B5/01	Aluminio	Blanco	Empotrar en techo	PLC	No	G24q3	1

Luminario cuadrado de empotrar LI de LED con 2 lámparas PLC Blanco

Código	W	V	Hz	K	Base	Ángulo	lm	Piezas
A1F-2L9S41-F-B3/110	22	120-277	60	4 100	G24q3	75°	2 300	1

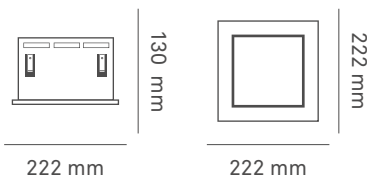
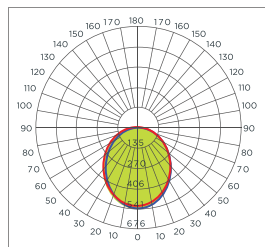
NOM

LED

Carcasa

Código	Cuerpo	Terminado	Aplicaciones	Tipo de lámpara	Lámpara incluida	Base	Piezas
A1F-0S9S0-G-B3/00	Aluminio	Blanco	Empotrar en techo	PLC	No	G24q3	1

Luminario cuadrado de sobreponer de LED con 2 lámparas PLC blanco

Código	W	V	Hz	K	Base	Ángulo	lm	Piezas
A4F-2L9S41-F-B3/110	22	120-277	50/60	4 100	G24q3	75°-65°	2 300	1

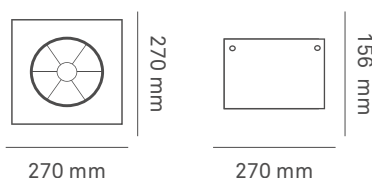
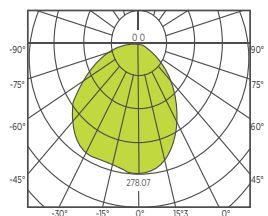

NOM
LED

Carcasa

Código	Cuerpo	Terminado	Aplicaciones	Tipo de lámpara	Lámpara incluida	Base	Piezas
A4F-0S10S0-G-B3/00	Aluminio	Blanco	Sobreponer en techo	PLC	No	G24q3	1

Luminario circular de empotrar VE de LED con 2 lámparas PLC blanco

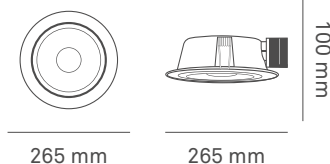
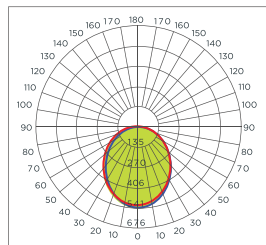
Código	W	V	Hz	K	Base	Ángulo	lm	Piezas
A1F-2L9S27-F-B1/110	22	120-277	50/60	4 100	G24q3	75°	2 300	1



Carcasa

Código	Cuerpo	Terminado	Aplicaciones	Tipo de lámpara	Lámpara incluida	Base	Piezas
A1F-0S9S0-G-B1/00	Aluminio	Satinado	Empotrar en techo	PLC	No	G24q3	1

Luminario circular de empotrar LV de LED con 2 lámparas PLC blanco

Código	W	V	Hz	K	Base	Ángulo	lm	Piezas
A1F-2L9S27-F-B1/111	22	120-277	50/60	4 100	G24q3	75°	2 300	1

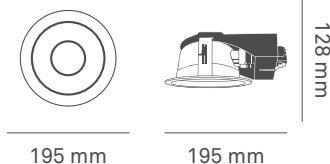
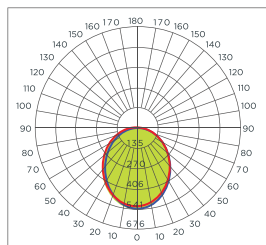

Carcasa

Código	Cuerpo	Terminado	Aplicaciones	Tipo de lámpara	Lámpara incluida	Base	Piezas
A1F-0S9S0-G-B1/01	Aluminio	Blanco	Empotrar en techo	PLC	No	G24q3	1



Luminario circular de empotrar VL de LED con 2 lámparas PLC blanco

Código	W	V	Hz	K	Base	Ángulo	lm	Piezas
A1F-2L9S27-F-B1/112	22	120-277	50/60	4 100	G24q3	75°	2 300	1

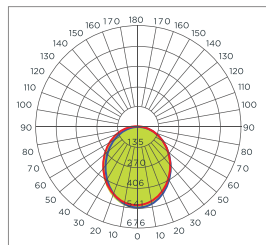

270 mm

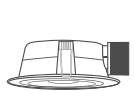

270 mm

100 mm



NOM
LED

Carcasa

Código	Cuerpo	Terminado	Aplicaciones	Tipo de lámpara	Lámpara incluida	Base	Piezas
A1F-0S9S0-G-B1/02	Aluminio	Blanco	Empotrar en techo	PLC	No	G24q3	1

Luminario circular de sobreponer de LED con 2 lámparas PLC blanco

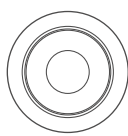
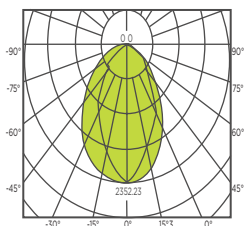
Código	W	V	Hz	K	Base	Ángulo	lm	Piezas
A4F-2L10S41-F-B1/110	22	120-277	50/60	4 100	G24q3	75°	2 300	1



300 mm



300 mm

100 mm



NOM
LED

Carcasa

Código	Cuerpo	Terminado	Aplicaciones	Tipo de lámpara	Lámpara incluida	Base	Piezas
A4F-0S10S0-G-B1/00	Aluminio	Blanco	Sobreponer en techo	PLC	No	G24q3	1

Luminario cuadrado de empotrar de LED blanco

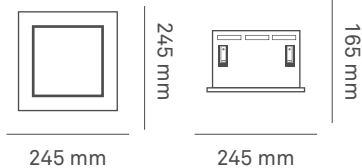
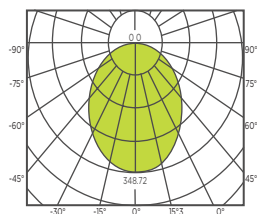
Código	W	V	Hz	K	lm	Vida (horas)	Piezas
A1F-1L8S27-G-B2/200	20	120-240	60	4 100	1 440	35 000	1



Luminario cuadrado de empotrar de LED dirigible blanco

Código	W	V	Hz	K	lm	Vida (horas)	Piezas
A1D-1L8S27-C-B3/60	6	120-240	60	2 700	480	35 000	1

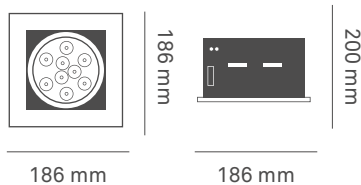
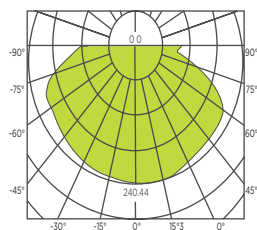

Luminario cuadrado de empotrar de LED con difusor tipo pirámide de acrílico blanco

Código	W	V	Hz	K	lm	Vida (horas)	Piezas
AFL104A	20	110-240	60	4 200	1 500	35 000	1

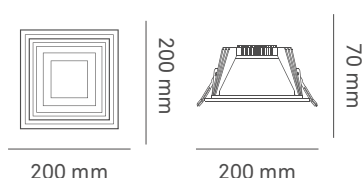
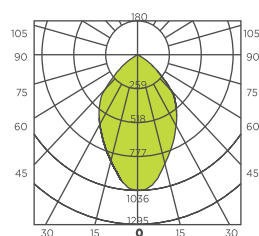

Luminario cuadrado de empotrar de LED 1 salida direccional con reflector especular gris

Código	W	V	Hz	K	lm	Vida (horas)	Piezas
AF001ABL	25	120-240	60	4 200	2 120	35 000	1

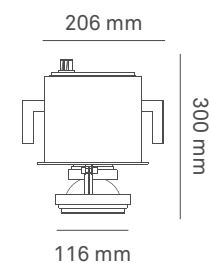
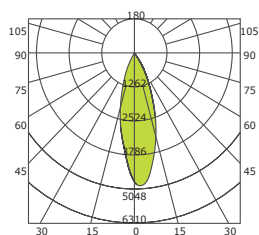

Luminario cuadrado de empotrar de LED 2 salidas dirigible con reflector especular gris

Código	W	V	Hz	K	lm	Vida (horas)	Piezas
AF002ABL	2x25	110-240	60	4 200	4 180	35 000	1

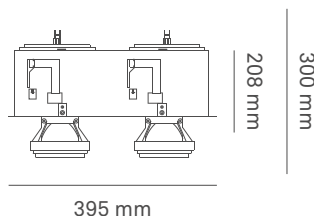
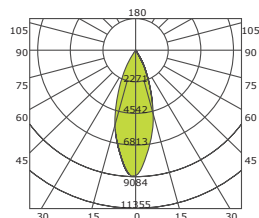

Luminario cuadrado de empotrar de LED 1 salida dirigida con reflector circular de acrílico blanco

Código	W	V	Hz	K	lm	Vida (horas)	Piezas
AFL100	10	110-240	60	3 000	870	35 000	1

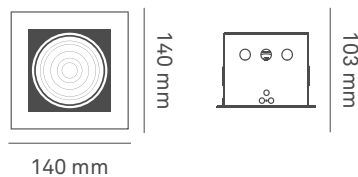
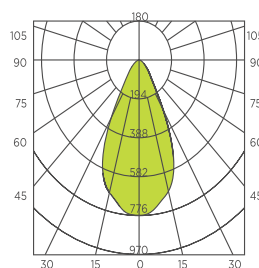

Luminario cuadrado de empotrar de LED 2 salidas dirigible con reflector circular de acrílico blanco

Código	W	V	Hz	K	lm	Vida (horas)	Piezas
AFL100-2	2x10	110-240	60	3 000	1 750	35 000	1

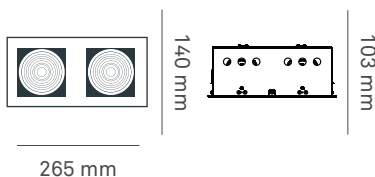
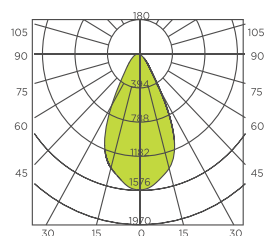

Luminario cuadrado de empotrar de LED 3 salidas dirigible de acrílico con reflector circular blanco

Código	W	V	Hz	K	lm	Vida (horas)	Piezas
AFL100-3	3x10	110-240	60	3 000	2 450	35 000	1

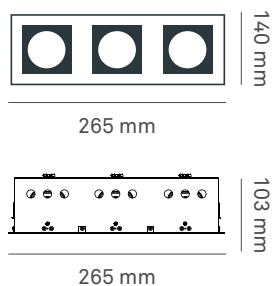
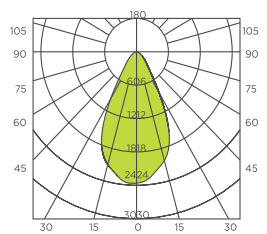

Luminario cuadrado de empotrar de LED 4 salidas dirigible de acrílico con reflector circular blanco

Código	W	V	Hz	K	lm	Vida (horas)	Piezas
AFL100-4	4x10	110-240	60	3 000	3 280	35 000	1

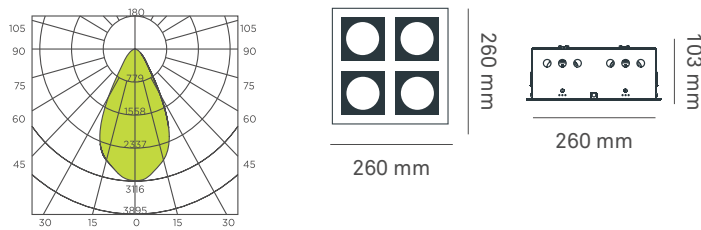

Luminario cuadrado de empotrar de LED 1 salida dirigida especular con reflector circular blanco

Código	W	V	Hz	K	lm	Vida (horas)	Piezas
AFL72A	6.5	110-240	60	3 000	525	35 000	1

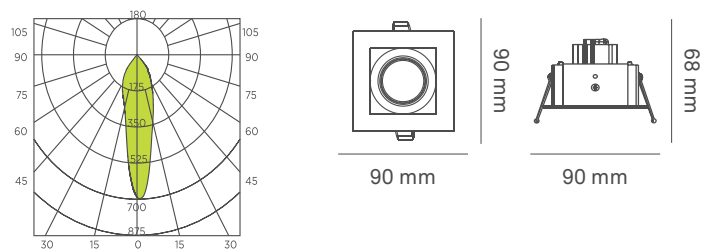

Luminario cuadrado de empotrar de LED 2 salidas dirigible especular con reflector circular blanco

Código	W	V	Hz	K	lm	Vida (horas)	Piezas
AFL72A-2	2x6.5	110-240	60	3 000	1 030	35 000	1

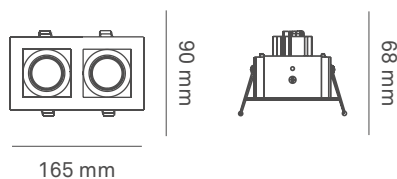
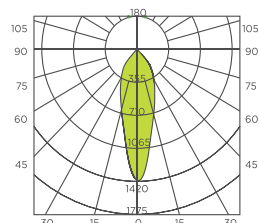

Luminario cuadrado de empotrar de LED 3 salidas dirigible especular con reflector circular blanco

Código	W	V	Hz	K	lm	Vida (horas)	Piezas
AFL72A-3	3x6.5	110-240	60	3 000	1 550	35 000	1

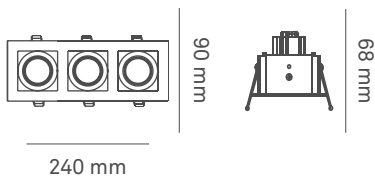
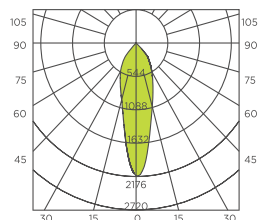

Luminario cuadrado de empotrar de LED 4 salidas dirigible especular con reflector circular blanco

Código	W	V	Hz	K	lm	Vida	Piezas
AFL72A-4	4x6.5	110-240	60	3 000	2 070	35 000	1

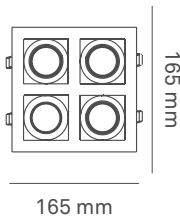
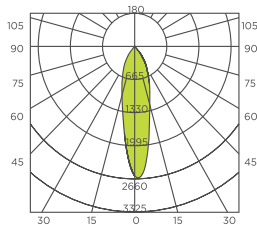

68 mm



Luminario cuadrado de empotrar de LED 1 salida fijo especular con reflector cuadrado blanco

Código	W	V	Hz	K	lm	Vida	Piezas
AFL72B	10	110-240	60	3 000	840	35 000	1

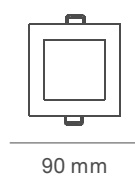
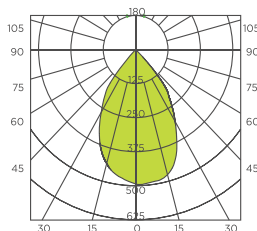
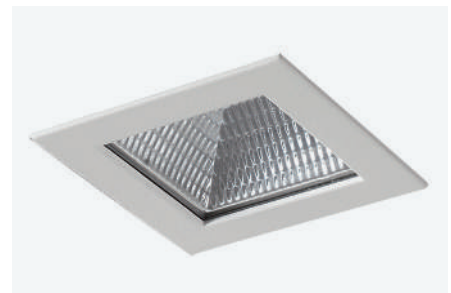

90 mm



91 mm



Luminario cuadrado de empotrar de LED 2 salidas fijo especular con reflector cuadrado blanco

Código	W	V	Hz	K	lm	Vida (horas)	Piezas
AFL72B-2	2x10	220-240	60	3 000	1 650	35 000	1

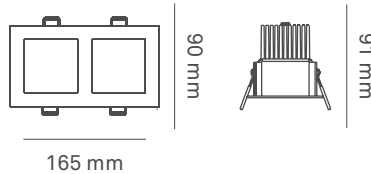
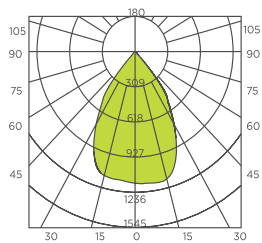

Luminario cuadrado de empotrar de LED 3 salidas fijo especular con reflector cuadrado blanco

Código	W	V	Hz	K	lm	Vida (horas)	Piezas
AFL72B-3	3x10	110-240	60	3 000	2 480	35 000	1

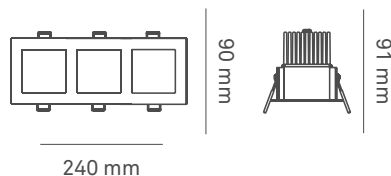
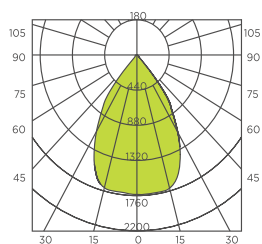

Luminario cuadrado de empotrar de LED con difusor cuadrado de acrílico blanco

Código	W	V	Hz	K	lm	Vida (horas)	Piezas
AF8031L	20	110-240	60	4 200	1 698	35 000	1

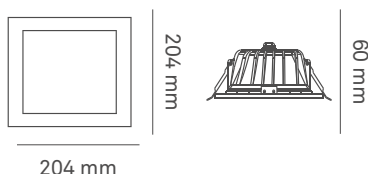
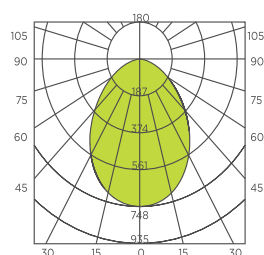

Luminario downlight de LED

Código	W	V	Hz	K	Vida (horas)	Piezas
9403150	9	100-240	50/60	3 000	30 000	1
9403152	9	100-240	50/60	6 500	30 000	1
9403165	12	100-240	50/60	3 000	30 000	1



Luminario downlight de LED con color de temperatura ajustable

Código	W	V	Hz	Dimensiones	lm	Vida	Piezas
				AxB (mm)			
9403162	10	100-277	60	110x37	800	30 000	1

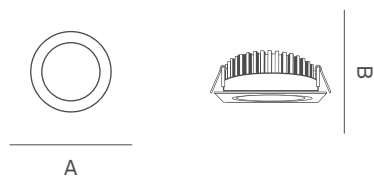

Luminario downlight dirigible de LED

Código	W	V	Hz	K	lm	Vida	Piezas
						(horas)	
9403155	9	100-240	60	3 000	800	30 000	1

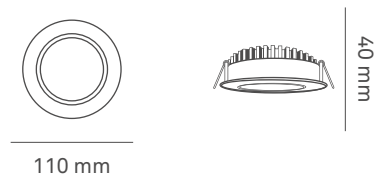

Luminario circular de empotrar de LED fijo especular blanco

Código	W	V	Hz	K	lm	Vida (horas)	Piezas
A1F-1L8S27-G-B1/5.40	5.4	120-240	60	2 700	400	35 000	1

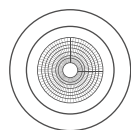
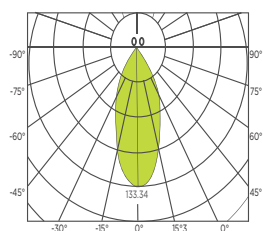

118 mm



90 mm



Luminario circular de empotrar de LED con pantalla de acrílico blanco

Código	W	V	Hz	K	lm	Vida (horas)	Piezas
AF3018YL	10	110-240	60	3 000	550	35 000	1
AF8018YL	20	110-240	60	4 200	1 180	35 000	1



AF3018YL

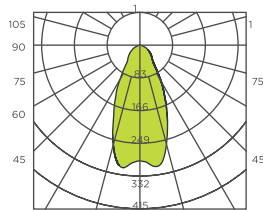

AF8018YL

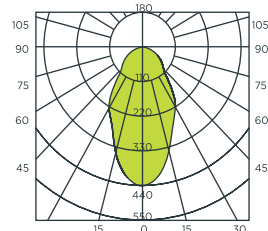

225 mm

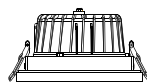

72 mm



Luminario circular de empotrar de LED con reflector especular blanco

Código	W	V	Hz	K	lm	Vida (horas)	Piezas
AF5026LA	10	110-240	60	3 000	740	35 000	1

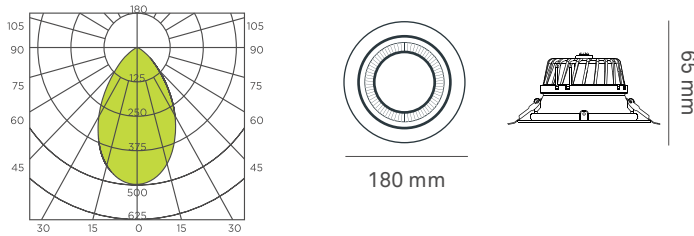

Luminario circular de empotrar de LED con reflector cónico especular blanco

Código	W	V	Hz	Dimensiones Ax B (mm)	K	lm	Vida (horas)	Piezas
AFL62A	10	110-240	60	131x70	3 000	830	35 000	1
AFL62B	15	120-240	60	162x74	4 200	1 140	35 000	1
AFL62C	20	110-240	60	190x80	4 200	1 605	35 000	1

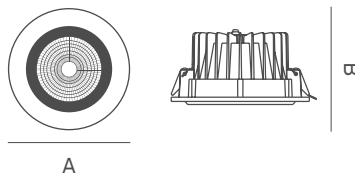
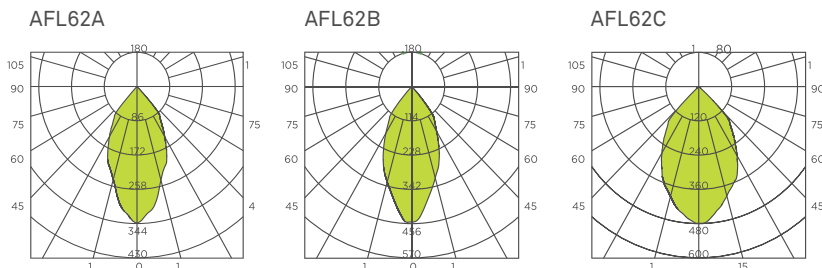

Luminario circular de empotrar de LED fijo de aluminio

Código	W	V	Hz	K	lm	Vida (horas)	Piezas
A1F-1L8S27-G-A1/2.50	2.5	120-240	60	2 700	200	35 000	1

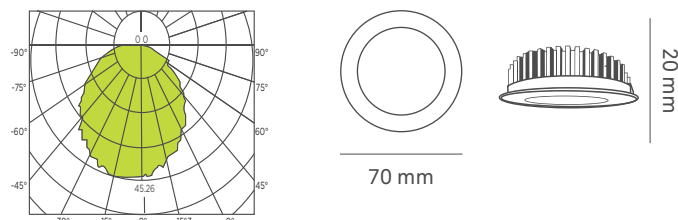

Luminario circular de empotrar de LED con difusor de acrílico blanco

Código	W	V	Hz	K	lm	Vida (horas)	Piezas
AF2040L	6	110-240	60	3 000	418	35 000	1

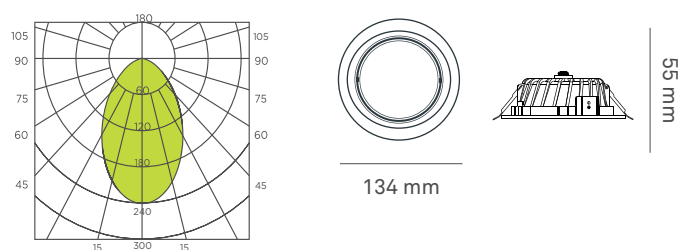

Luminario circular de empotrar de LED con difusor de acrílico blanco

Código	W	V	Hz	K	lm	Vida (horas)	Piezas
AFL88B	10	110-240	60	3 000	650	35 000	1

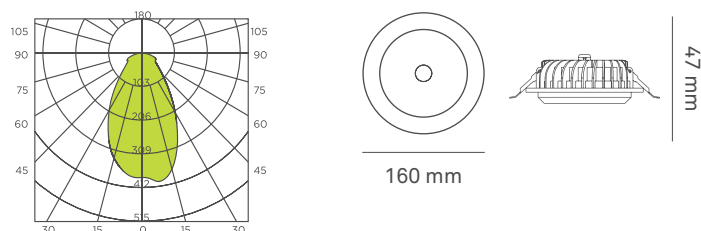

Luminario circular de empotrar de LED con marco de cristal blanco

Código	W	V	Hz	K	lm	Vida (horas)	Piezas
AFL105A	12	110-240	60	3 000	800	35 000	1

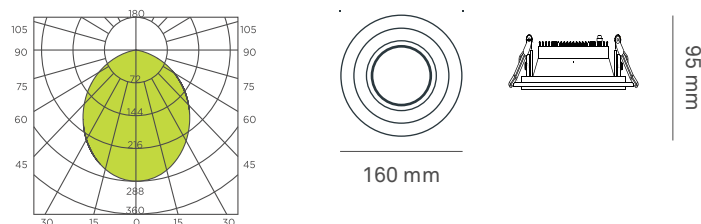

Luminario circular de empotrar de LED dirigible con reflector especular blanco

Código	W	V	Hz	K	lm	Vida (horas)	Piezas
AFL90	6.5	110-240	60	3 000	550	35 000	1

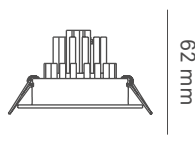
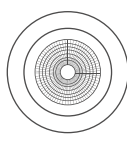
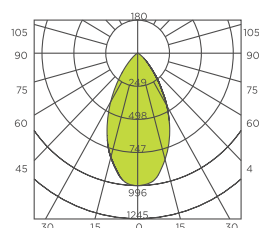

Luminario circular de empotrar de LED dirigible con reflector especular blanco

Código	W	V	Hz	K	lm	Vida (horas)	Piezas
AFL98A	10	110-240	60	3 000	850	35 000	1

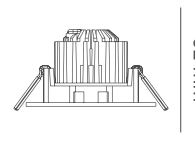
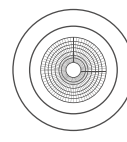
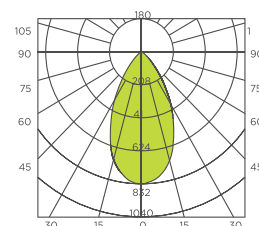

Luminario circular de empotrar de LED dirigible con reflector cónico especular blanco

Código	W	V	Hz	K	lm	Vida (horas)	Piezas
AF8063L	25	110-240	60	4 200	2 010	35 000	1

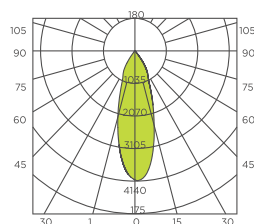

204 mm

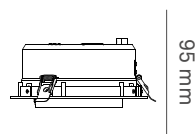

95 mm



Luminario circular de empotrar de LED dirigible blanco

Código	W	V	Hz	K	lm	Vida (horas)	Piezas
A1D-1L8S27-G-A1/30	3	120-240	60	2 700	240	35 000	1

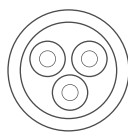
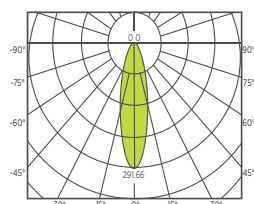

94 mm



56 mm



Luminario circular de sobreponer de LED con difusor de acrílico blanco

Código	W	V	Hz	K	lm	Vida (horas)	Piezas
A4F-1L8S27-C-B1/200	20	120-240	60	3 000	1 440	35 000	1

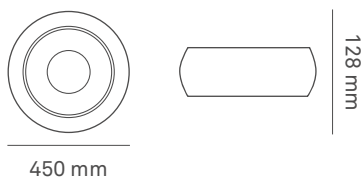
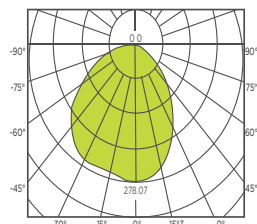

Luminario circular de sobreponer de LED con acrílico circular blanco

Código	W	V	Hz	K	lm	Vida (horas)	Piezas
AFL78C	20	110-240	60	4 200	1 635	35 000	1

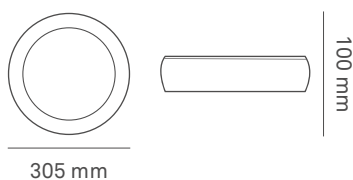
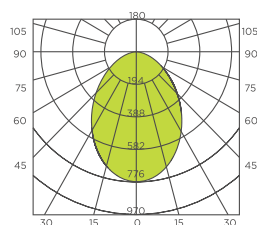

Luminario circular de sobreponer de LED con difusor de acrílico blanco

Código	W	V	Hz	K	lm	Vida (horas)	Piezas
AFL78	30	110-240	60	4 200	2 040	35 000	1

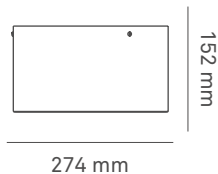
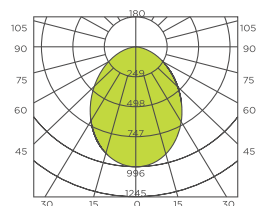

Luminario circular de sobreponer de LED con difusor de acrílico blanco

Código	W	V	Hz	K	lm	Vida (horas)	Piezas
AFL78A	15	110-240	60	4 200	1 027	35 000	1

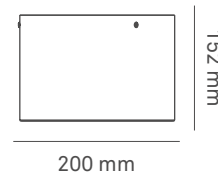
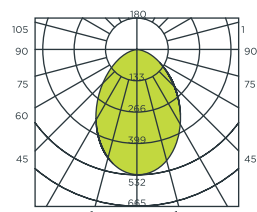

Luminario circular de sobreponer de LED con reflector de acrílico blanco

Código	W	V	Hz	K	lm	Vida (horas)	Piezas
AF9009BL	10	110-240	60	3 000	850	35 000	1

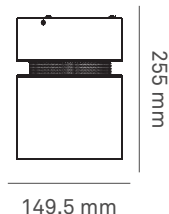
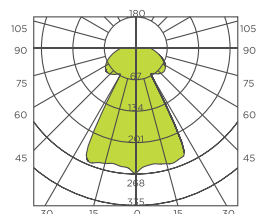

Plafón cuadrado liso de LED

Código	W	V	Hz	K	lm	Vida (horas)	Piezas
9403255	12	100-240	50/60	6 500	840	30 000	1

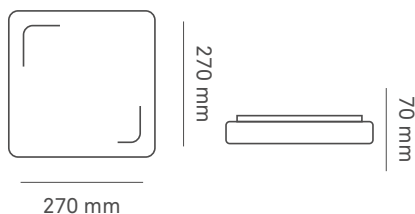

Plafón circular liso de LED

Código	W	V	Hz	K	lm	Vida (horas)	Piezas
9403250	12	100-240	50/60	6 500	840	30 000	1

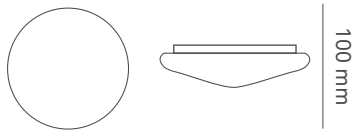

290 mm



Luminario tipo cono de suspender de LED

Código	W	V	Hz	K	lm	Vida (horas)	Piezas
AF44L	20	110-240	60	4 200	1 440	35 000	1

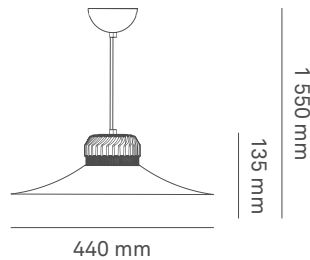
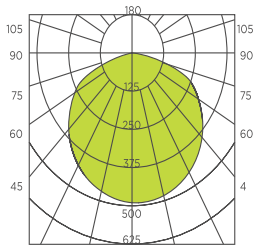

Luminario tipo cono de suspender de LED

Código	W	V	Hz	K	lm	Vida (horas)	Piezas
AF36BL	20	110-240	60	4 200	1 305	35 000	1

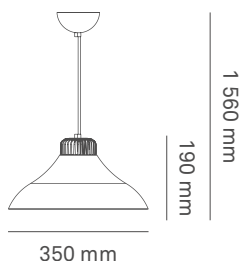
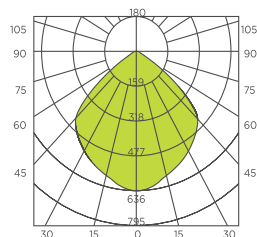

Luminario tipo campana de suspender de LED

Código	W	V	Hz	K	lm	Vida (horas)	Piezas
AF30BL	35	110-240	60	4 200	2 650	35 000	1

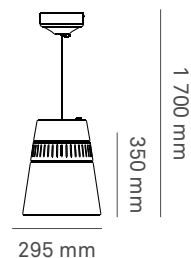
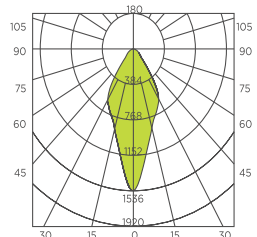

Luminario tipo campana de suspender de LED

Código	W	V	Hz	K	lm	Vida (horas)	Piezas
AF12JL	30	110-240	60	4 200	2 340	35 000	1

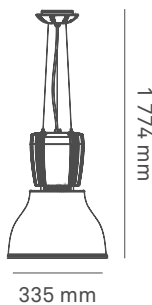
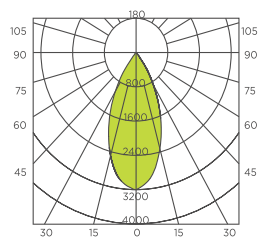

Luminario colgante de LED

Código	Color	W	V	Hz	K	Base	lm	Vida (horas)	Piezas
9403193	○	18	120-240	60	4 100	E-26	1 200	25 000	6

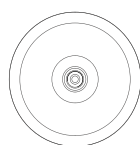

Ø 220 mm

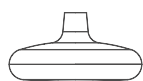

145 mm



Luminario rectangular de sobreponer en riel de LED blanco

Código	W	V	Hz	K	lm	Vida (horas)	Piezas
A7M-1L8S27-C-B0/80	8	120-240	60	2 700	580	35 000	1

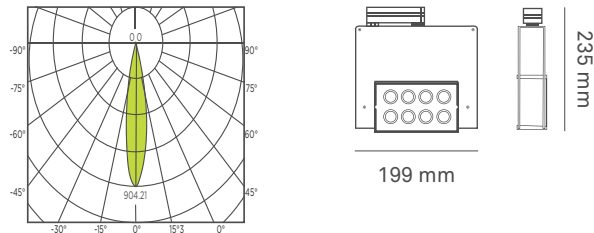

Luminario circular de sobreponer en riel de LED blanco

Código	W	V	Hz	K	lm	Vida (horas)	Piezas
A7M-1L8S27-C-B0/90	9	120-240	60	2 700	600	35 000	1

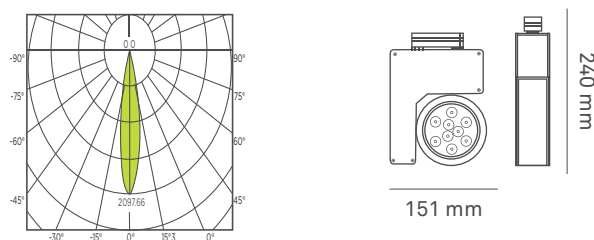

Luminario circular de sobreponer en riel de LED blanco

Código	W	V	Hz	K	lm	Vida (horas)	Piezas
A7M-1L8S27-C-B0/60	6	120-240	60	2 700	440	35 000	1

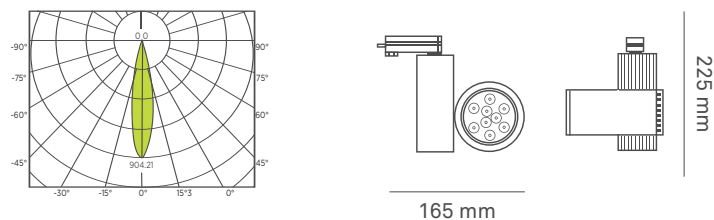

Luminario circular de sobreponer en riel de LED con reflector cónico especular blanco

Código	W	V	Hz	K	lm	Vida (horas)	Piezas
A7M-1L8S27-C-B0/230	23	120-240	60	2 700	1 610	35 000	1

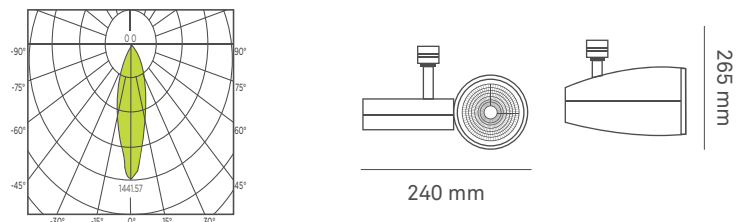

Luminario circular de sobreponer en riel de LED con reflector cónico especlar blanco

Código	W	V	Hz	K	lm	Vida (horas)	Piezas
AFST122BL	25	110-240	60	4 200	2 010	35 000	1

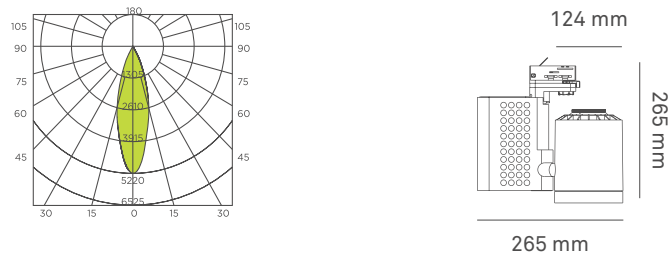

Luminario circular de sobreponer en riel de LED con reflector cónico especlar blanco

Código	W	V	Hz	K	lm	Vida (horas)	Piezas
AFST135L	35	120-240	60	4 200	3 219	35 000	1

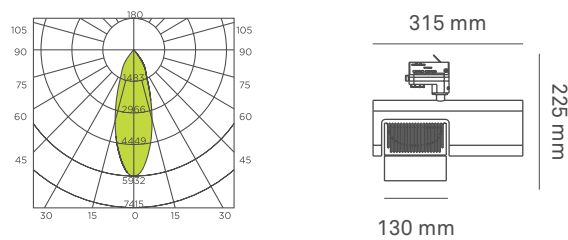

Luminario circular de sobreponer en riel de LED con reflector cónico especular blanco

Código	W	V	Hz	K	lm	Vida (horas)	Piezas
AFST136CL	35	110-240	60	4 200	2 780	35 000	1

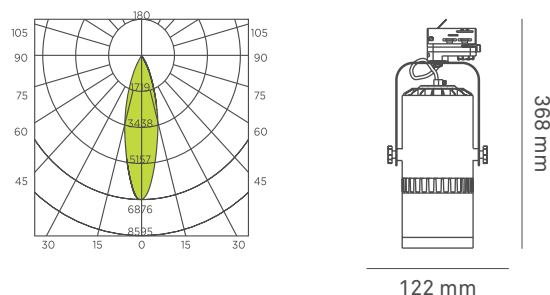

Riel para luminario

Código	W	V	Hz	A	No. de Hilos	Longitud (m)	Piezas
	máx.						
RIEL3FX1M	2 000	127	60	10	3	1	1
RIEL4FX1M	3 900	127-220	60	15	4	1	1
RIEL4FX2M	3 900	127-220	60	15	4	2	1



Conectores para riel 4 hilos

Código	Descripción	Piezas
CONNECT4FI	Conector para Riel "I"	1
CONNECT4FL	Conector para Riel "L"	1
CONNECT4FT	Conector para Riel "T"	1
CONNECT4FX	Conector para Riel "X"	1



Luminario rectangular de sobreponer a muro de LED blanco

Código	W	V	Hz	K	lm	Vida (horas)	Piezas
AFWL171	5	110-240	60	3 000	355	35 000	1

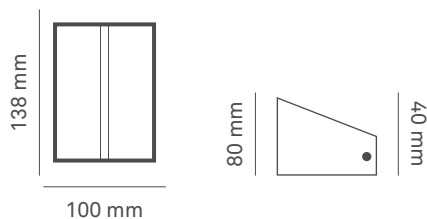
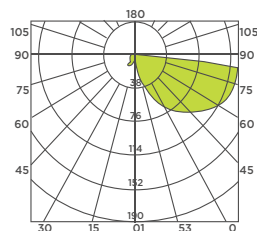
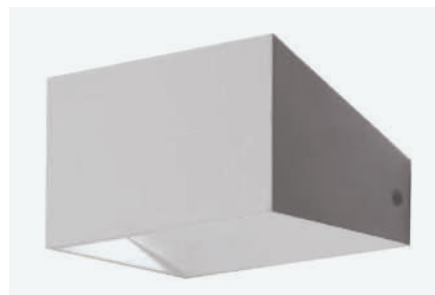

Luminario circular de sobreponer a muro de LED dirigible gris

Código	W	V	Hz	K	lm	Vida (horas)	Piezas
AF8028L	12	127-240	60	4 200	780	35 000	1

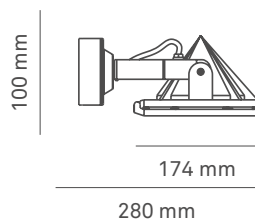
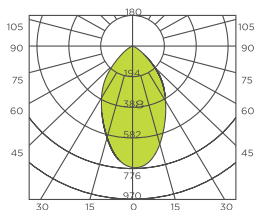

Luminario cuadrado de sobreponer a muro de LED exterior dirigible blanco

Código	W	V	Hz	K	lm	Vida (horas)	Piezas
A5M-1L8S27-C-B0/150	15	120-240	60	2 700	1 200	35 000	1

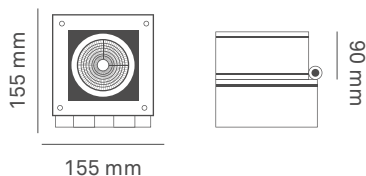
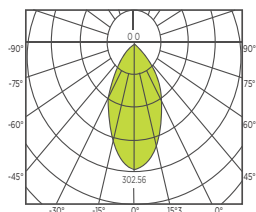

Luminario tipo pirámide de sobreponer a muro de LED blanco

Código	W	V	Hz	K	lm	Vida (horas)	Piezas
AFWL169	9	110-240	60	3 000	840	35 000	1

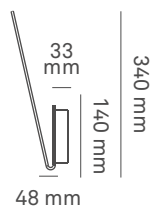
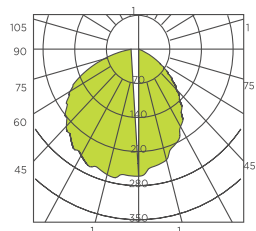



Farol clásico

Código	Color	Descripción	W	V	Hz	Base	Piezas
9400420	●	Farol de pared clásico	100	127	60	E-26	1
9400421	○	Farol de pared clásico	100	127	60	E-26	1

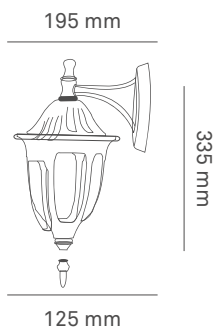

NOM

Características

- Material: aluminio inyectado.
- Terminado: pintura color negro o blanco.
- Pantalla: cristal transparente.

Farol colonial

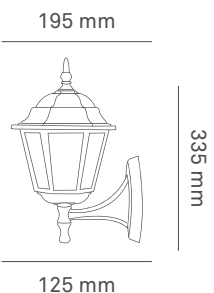
Código	Color	Descripción	W	V	Hz	Base	Piezas
9400425	●	Farol de pared colonial	100	127	60	E-26	1
9400426	○	Farol de pared colonial	100	127	60	E-26	1



NOM

Características

- Material: aluminio inyectado.
- Terminado: pintura color negro o blanco.
- Pantalla: cristal transparente.

Luminario cuadrado de empotrar a piso de aluminio

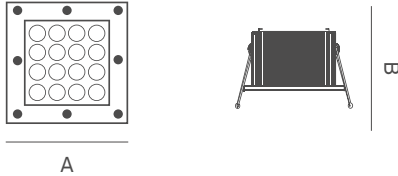
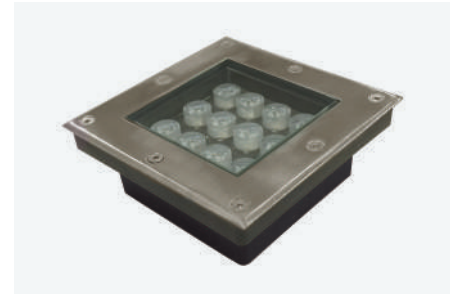
Código	W	V	Hz	K	Dimensiones	lm	Vida	Piezas
					AxB (mm)			
9403065	12	120-277	60	3 000	160x58	1 200	35 000	1



Lámpara ahorradora de LED

Código	Descripción	W	V	Hz	K	Ángulo	lm	Vida	Dimensiones	Piezas
								(horas)	AxBxC (mm)	
9401250	Lámpara ahorradora de LED	40	120-240	60	6 500	120°	4 000	20 000	245x285x150	1
9401260	Lámpara ahorradora de LED	55	120-240	60	6 500	120°	5 000	20 000	245x285x150	1

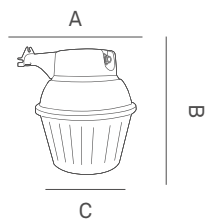

Características

- Cuerpo de policarbonato.
- Difusor prismático de acrílico.
- Montaje de poste o pared.
- Incluye lámparas fluorescentes compactas y fotocelda.

Lámpara suburbana de LED

Código	Descripción	W	V	Hz	K	Ángulo	lm	Vida	Dimensiones	Piezas
								(horas)	AxBxC (mm)	
9401270	Lámpara suburbana de LED	50	120-240	60	6 500	120°	4 500	20 000	359x113x209	1

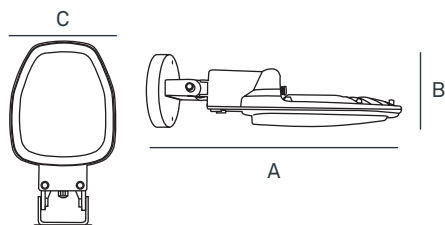

Características

- Cuerpo de aluminio inyectado.
- Difusor de policarbonato inyectado.
- Montaje de pared.



Proyectores de LED

Código	W	V	Hz	K	lm	Dimensiones	Tipo de LED	Vida	Piezas
						AxBxC (mm)		(horas)	
9403236	100	127-240	60	4 100	10 000	45x42x34.5	COB	50 000	1
9403238	150	127-240	60	4 100	15 000	45x42x34.5	COB	50 000	1



Proyectores de LED slim 6 500 k

Código	W	V	Hz	K	lm	Dimensiones	Tipo de LED	Vida	Piezas
						AxBxC (mm)			
9403290	10	127-240	60	6 500	800	90x79x26	SMD	30 000	1
9403291	20	127-240	60	6 500	1 600	125x118x26	SMD	30 000	1
9403292	30	127-240	60	6 500	2 400	183x177x26	SMD	30 000	1
9403293	50	127-240	60	6 500	4 000	255x217x28	SMD	30 000	1
9403294	100	127-240	60	6 500	8 000	282x271x29	SMD	30 000	1
9403295	150	127-240	60	6 500	12 000	330x237x37	SMD	30 000	1

9403290

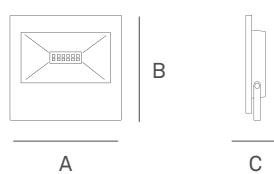
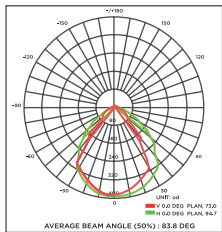

Proyectores de LED slim 3 000 k

Código	W	V	Hz	K	lm	Dimensiones	Tipo de LED	Vida	Piezas
						AxBxC (mm)			
9403296	10	127-240	60	3 000	800	90x79x26	SMD	30 000	1
9403297	20	127-240	60	3 000	1 600	125x118x26	SMD	30 000	1
9403298	30	127-240	60	3 000	2 400	183x177x26	SMD	30 000	1
9403299	50	127-240	60	3 000	4 000	255x217x28	SMD	30 000	1

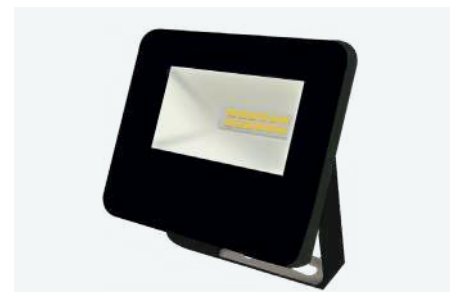
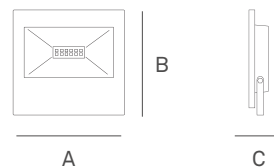
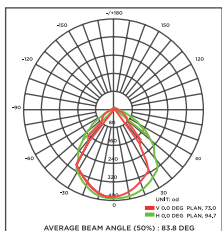



Lámpara tipo regleta de LED

Código	W	V	Hz	K	lm	Dimensiones	Tipo de LED	Vida	Piezas
						AxB (mm)		(horas)	
9401440	4	100-240	60	6 500	360	307x39	SMD	30 000	1
9401442	4	100-240	60	3 000	360	307x39	SMD	30 000	1
9401445	8	100-240	60	6 500	720	567x39	SMD	30 000	1
9401447	8	100-240	60	3 000	720	567x39	SMD	30 000	1
9401450	12	100-240	60	6 500	1 080	867x39	SMD	30 000	1
9401452	12	100-240	60	3 000	1 080	867x39	SMD	30 000	1
9401455	16	100-240	60	6 500	1 440	1 169x39	SMD	30 000	1
9401457	16	100-240	60	3 000	1 440	1 169x39	SMD	30 000	1

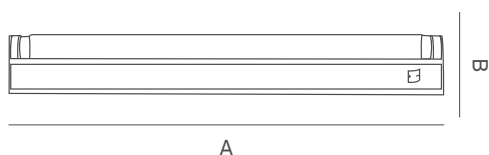

Lámpara de gabinete slim de LED

Código	W	V	Hz	K	lm	Dimensiones	Tipo de LED	Vida	Piezas
						AxBxC (mm)		(horas)	
9401460	1.6	100-240	50/60	3 000	155	228x10x9	SMD	50 000	1
9401465	2.4	100-240	50/60	3 000	240	340x10x9	SMD	50 000	1
9401470	7.2	100-240	50/60	3 000	700	890x10x9	SMD	50 000	1
9401475	9.7	100-240	50/60	3 000	950	1109x10x9	SMD	50 000	1

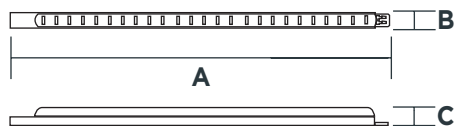

Driver para lámparas de gabinete slim de LED

Código	W	V	Piezas
9401480	48	100-240	1



NOM

Accesorios para lámpara de gabinete slim

Código	Descripción	Piezas
9401481	Cable conector de drive a lámpara slim	1
9401482	Cable conector para lámpara de gabinete slim	1



Luminario tipo soft-light de empotrar de LED

Código	W	V	Hz	K	Base	Ángulo	lm	Piezas
A1M-4L13A41-F-B4/360	36	120-277	50/60	4 100	T5	90°	3 600	1

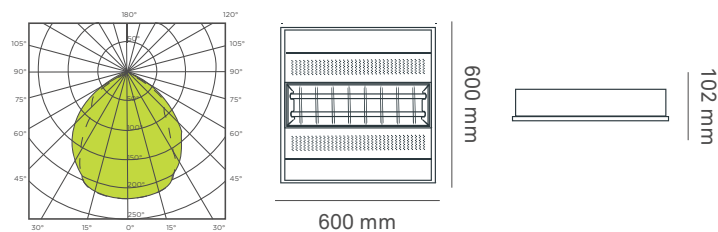

NOM **LED**

Carcasa

Código	Cuerpo	Terminado	Aplicaciones	Tipo de lámpara	Lámpara incluida	Base	Piezas
A1M-0S13S0-G-B4/00	Aluminio	Blanco	Empotrar en techo	Tubo T5	No	T5	1

55 mm

Luminario rectangular de suspender de LED con 2 lámparas con difusor acrílico aluminio

Código	W	V	Hz	K	Base	Ángulo	lm	Piezas
A3M-2L13F41-F-G-A6/360	36	100-277	50/60	4 100	T5	90°	3 600	1

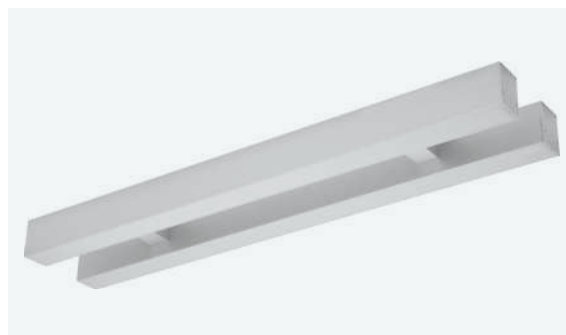
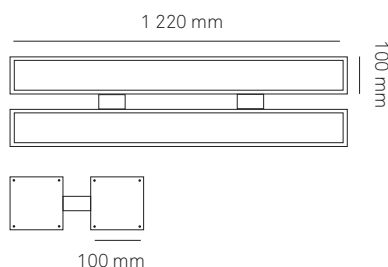
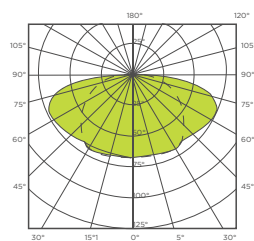

NOM
LED

Carcasa

Código	Cuerpo	Terminado	Aplicaciones	Tipo de lámpara	Lámpara incluida	Base	Piezas
A3M-0S13S0-G-A6/01	Aluminio	Satinado	Suspender en techo	Tubo T5	No	T5	1

Luminario ovalado de suspender de LED con 4 lámparas con difusor acrílico aluminio

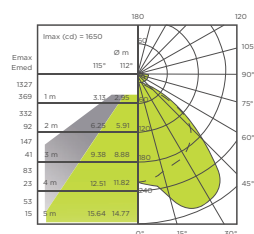
Código	W	V	Hz	K	Base	Ángulo	lm	Piezas
A3M-4L13F41-F-G-A10/720	72	120-277	50/60	4 100	T5	90°	7 200	1



NOM
LED

Carcasa

Código	Cuerpo	Terminado	Aplicaciones	Tipo de lámpara	Lámpara incluida	Base	Piezas
A3M-0S13S0-G-A10/02	Aluminio	Satinado	Empotrar en techo	Tubo T5	No	T5	1

Luminario de suspender de LED

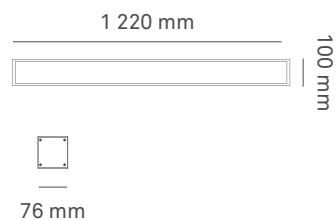
Código	W	V	Hz	K	lm	Acabado	Piezas
A3M-1L13F41-F-N-A6/360	36	100-277	50/60	4 100	4 680	Negro	1



Luminario panel de LED tipo C 120x30

Código	W	V	Hz	K	Ángulo	lm	Vida (horas)	Piezas
9403118	40	85-265	50/60	3 000	120°	3 825	50 000	1

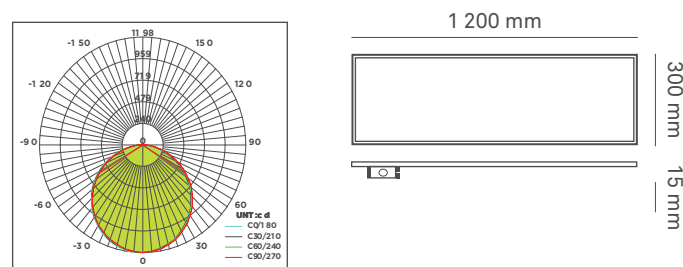

Panel backlight LED 60x60

Código	W	V	Hz	K	lm	Piezas
9403136	36	120/277	50/60	3 000	3 600	2
				4 100		
				6 000		

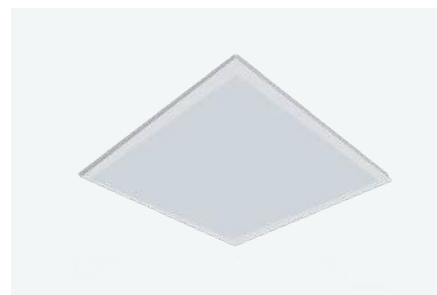

Panel backlight LED 120x60

Código	W	V	Hz	K	lm	Piezas
9403138	60	120-277	50/60	3 000	6 000	1
				4 100		
				6 000		

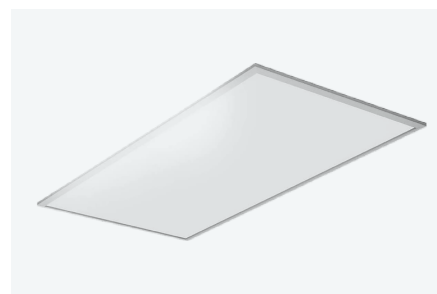

Accesorios para luminarios paneles de LED tipo C

Código	Descripción	Piezas
9403124	Juego de colgadores para suspender panel 60x60/120x30	1
9403131	Marco para sobreponer panel de LED tipo C 60x60	1
9403133	Marco para sobreponer panel de LED tipo C 120x60	1

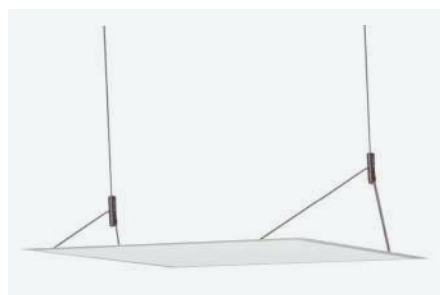

Juego de colgadores para suspender



Accesorio para sobreponer



Marco para sobreponer

Luminario high bay tipo ESQ

Fluorescente

Código	W	V	Hz	K	Base	Ángulo	Piezas
9401722*	216	120-277	50/60	—	G5	100°	1
9401727*	324	120-277	50/60	—	G5	100°	1
9401745**	324	120-277	50/60	4 100	G5	100°	1



* No incluye lámparas
** Incluye balastro electrónico y lámparas

LED

Código	W	V	Hz	K	Base	Ángulo	lm	Vida (horas)	Piezas
9401725LED41	112	110-277	60	4 100	G5	100°	14 000	25 000	1
9401720LED41	168	110-277	60	4 100	G5	100°	21 000	25 000	1

112/216 W

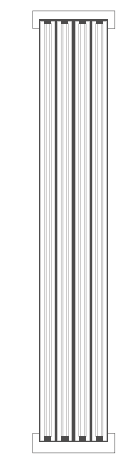

309 mm

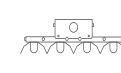

1 220 mm

55 mm

168/324 W

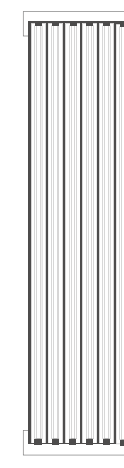

344 mm

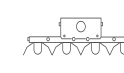

1 220 mm

60 mm



Fluorescente 216 W

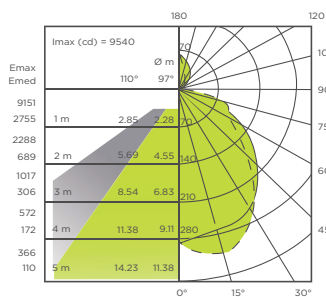

LED 112 W

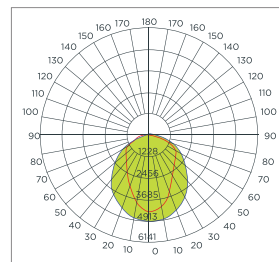

Estructura

Código	Descripción	Tipo de lámpara	Piezas
9401720	Estructura 4x28/54 W	T5	1
9401725	Estructura 6x28/54 W	T5	1

Características

- Cuerpo de lámina de acero.
- Pintura electrostática blanca con protector antioxidante.
- Reflector de aluminio especular.
- Incluye bases.

Luminario high bay tipo gabinete

Fluorescente

Código	W	V	Hz	K	Base	Ángulo	Piezas
9401729**	168	120-277	50/60	4 100	G5	100°	1



* No incluye lámparas
 ** Incluye balastro electrónico y lámparas

LED

Código	W	V	Hz	K	Base	Ángulo	Im	Vida	Piezas
								(horas)	
9401700LED41	112	110-277	60	4 100	G5	100°	14 000	25 000	1
9401700LED65	112	110-277	60	6 500	G5	100°	14 000	25 000	1
9401710LED41	168	110-277	60	4 100	G5	100°	21 000	25 000	1

112/216 W

168/324 W

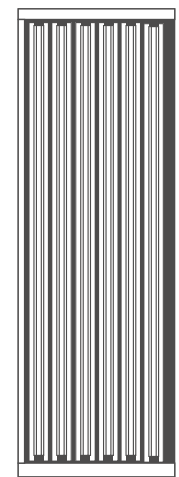
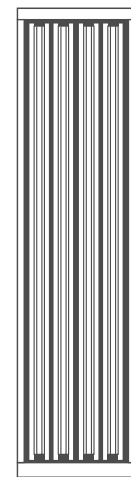

285 mm

410 mm

96 mm

96 mm



Fluorescente 216 W

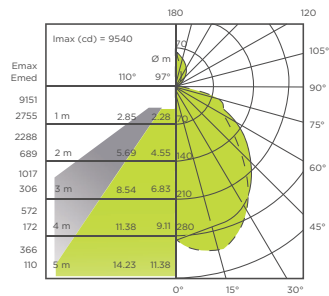

LED 112 W

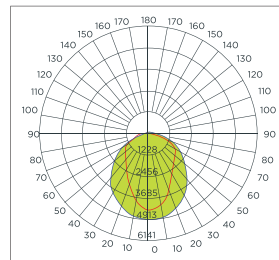

Luminario high bay de LED

Código	W	V	Hz	K	Ángulo	lm	Vida (horas)	Piezas
9401751	100	120/277	50 / 60	5 000	120°	13 000	50 000	1
9401755	200	120/277	50 / 60	5 000	120°	28 000	50 000	1



Características

- Cuerpo de lámina de acero.
- Pintura electrostática blanca con protector antioxidante.
- Reflector de aluminio especular.
- Incluye bases.
- Cuenta con certificación UL

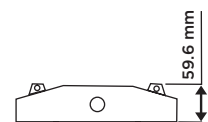
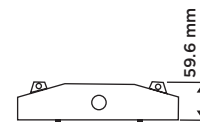
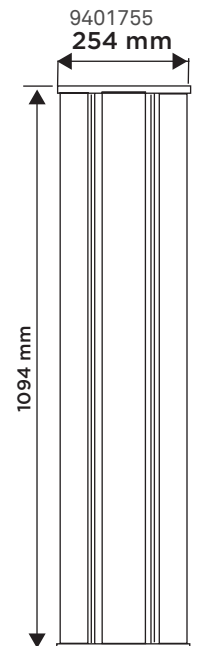
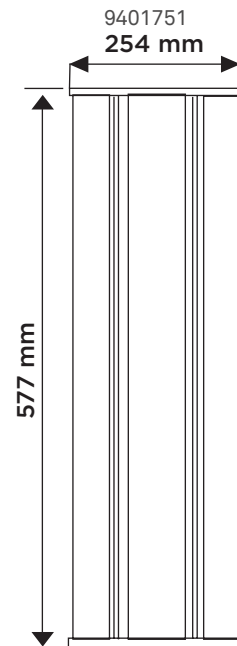

Luminario circular high bay de LED

Código	W	V	Hz	K	Ángulo	lm	Vida (horas)	Piezas
9401782	150	120-277	50/60	5 000	90°	21 000	50 000	1
9401787	200	120-277	50/60	5 000	90°	28 000	50 000	1

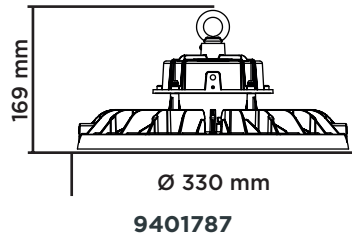
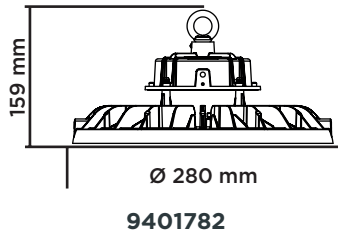

Campana de aluminio para luminario circular high bay para modelo 9401780

Código	Descripción	Piezas
CAM90AL	Campana de aluminio 90° para modelo 9401780	1

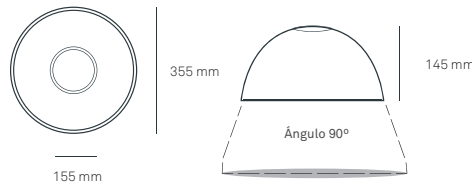

Campana de policarbonato para luminario circular high bay para modelo 9401780

Código	Descripción	Piezas
CAM70PC	Campana de policarbonato 70° para modelo 9401780	1

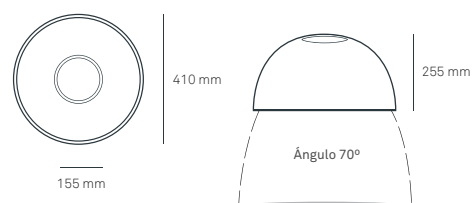



Campana de aluminio para luminario circular high bay

Código	Descripción	Piezas
9401790	Campana de aluminio 90° para high bay de 150 W	1
9401792	Campana de aluminio 90° para high bay de 200 W	1

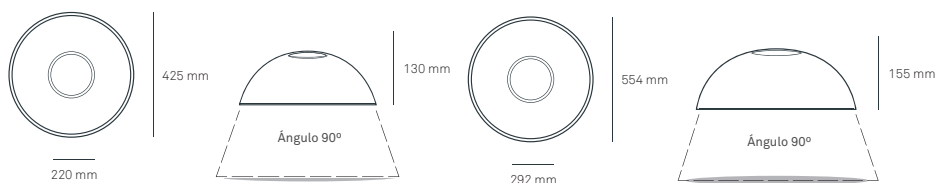

9401790

9401792

Soporte para luminario circular high bay para modelo 9401780

Código	Descripción	Piezas
9401786	Soporte para campana de LED para modelo 9401780	1



Soporte para high bay

Código	Descripción	Piezas
9401795	Soporte para high bay de 150 W	1
9401797	Soporte para high bay de 200 W	1



Estructura a prueba de polvo y goteo

Código	Descripción	Dimensiones	Piezas
		AxBxCxD (mm)	
9400504	Estructura 1x17 W	662x350x111x95	1
9400505	Estructura 1x14 W	662x350 x111x95	1
9400510	Estructura 2x32 W	1 272x700x111x145	1
9400512	Estructura 2x28/54 W	1 272x700x111x145	1



Características

- Cuerpo de policarbonato color gris RAL7035.
- Difusor de policarbonato transparente.
- Empaque de poliuretano expandido.
- Reflector de lámina de acero pintado electrostáticamente en blanco.
- Juego de herrajes para montaje suspendido o sobreponer en el techo.

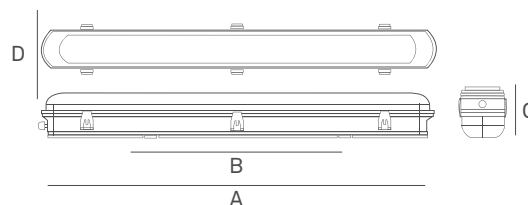

NOM



Luminario a prueba de polvo y goteo T8

Código	Descripción	V	Hz	K	Base	Tipo de lámpara	Ángulo	Piezas
9400504B*	1x17 W	120-127	60	—	G13	T8	80°	1
9400506A*	2x17 W	120-277	50/60	—	G13	T8	80°	1
9400504BT65**	1x17 W	120-127	60	6 500	G13	T8	80°	1
9400504AT65**	1x17 W	120-277	50/60	6 500	G13	T8	80°	1
9400506AT65**	2x17 W	120-277	50/60	6 500	G13	T8	80°	1
9400515B*	1x32 W	120-127	60	—	G13	T8	80°	1
9400515A*	1x32 W	120-277	50/60	—	G13	T8	80°	1
9400515BT41**	1x32 W	120-127	60	4 100	G13	T8	80°	1
9400515BT65**	1x32 W	120-127	60	6 500	G13	T8	80°	1
9400515AT41**	1x32 W	120-277	50/60	4 100	G13	T8	80°	1

* No incluye lámparas

** Incluye balastro electrónico y lámparas

NOM



Powered by
PHILIPS



Luminario a prueba de polvo y goteo T5

Código	Descripción	V	Hz	K	Base	Tipo de lámpara	Ángulo	Piezas
9400525P*	1x54 W	120-277	50/60	—	G5	T5	80°	1
9400505PT41**	1x14 W	120-277	50/60	4 100	G5	T5	80°	1
9400507PT41**	2x14 W	120-277	50/60	4 100	G5	T5	80°	1
9400515PT41**	1x28 W	120-277	50/60	4 100	G5	T5	80°	1
9400515PT65**	1x28 W	120-277	50/60	6 500	G5	T5	80°	1
9400525PT41**	1x54 W	120-277	50/60	4 100	G5	T5	80°	1
9400525PT65**	1x54 W	120-277	50/60	6 500	G5	T5	80°	1
9400520PT65**	2x54 W	120-277	50/60	6 500	G5	T5	80°	1

* No incluye lámparas

** Incluye balastro electrónico y lámparas



Powered by
PHILIPS



Luminario a prueba de polvo y goteo con tubos de LED Philips

Código	W	V	Hz	K	lm	Vida (horas)	Piezas
9400509LED41	36	110-277	60	4 100	3 700	30 000	1
9400509LED65	36	110-277	60	6 500	3 700	30 000	1

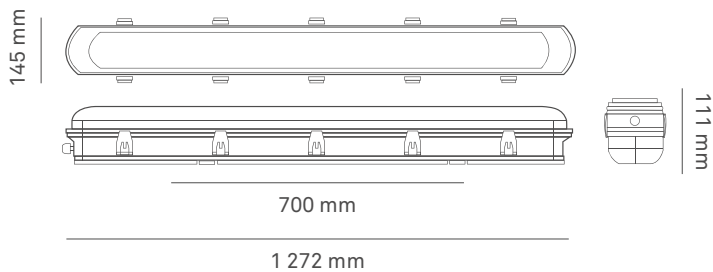

Powered by
PHILIPS

LED

Luminario a prueba de polvo y goteo de LED con disipador de calor

Código	W	V	Hz	K	lm	Vida (horas)	Piezas
9400540LED41	36	120-277	50/60	4 100	4 680	30 000	1
9400540LED65	36	120-277	50/60	6 500	4 680	30 000	1



· Incluye disipador de calor.

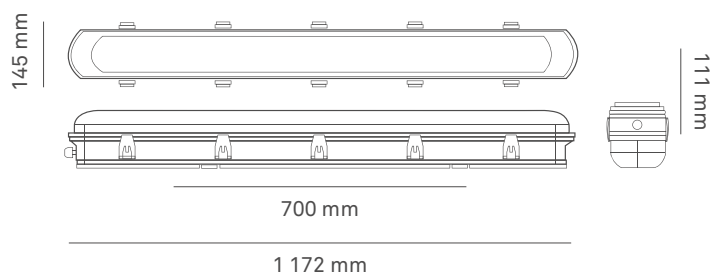

Luminario a prueba de polvo y goteo con tubos de LED

Código	W	V	Hz	K	lm	Vida (horas)	Piezas
9400545LED65	36	120-277	50/60	6 500	4 680	30 000	1

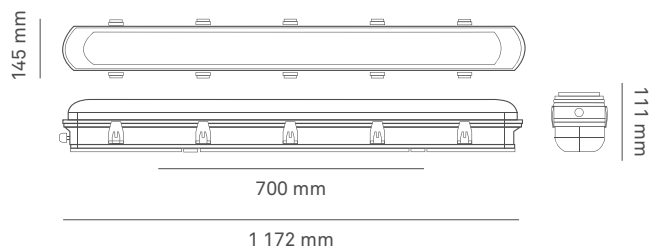

Luminario a prueba de polvo y goteo de LED

Código	W	V	Hz	K	lm	Vida (horas)	Piezas
9400550LED65	36	120-277	50/60	6 500	4 770	50 000	1

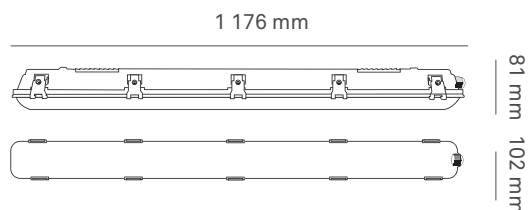

Luminario a prueba de polvo y goteo de LED

Código	W	V	Hz	K	Ángulo	lm	Vida (horas)	Piezas
				3 000				
9400555LEDCCT	36	120-277	50/60	4 100	120°	4 770	50 000	1
				6 500				
				3 000				
*PRO-ME-17CCT-180-V0	36	120-277	50/60	4 100		4 770	50 000	1
*Tablilla LED (Refacción)				6 500				

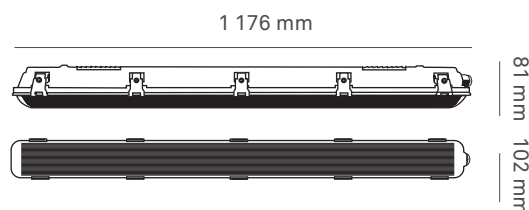

Kit de suspensión

Código	Descripción	Piezas
9403140	Kit de suspensión para luminario a prueba de polvo y goteo	1

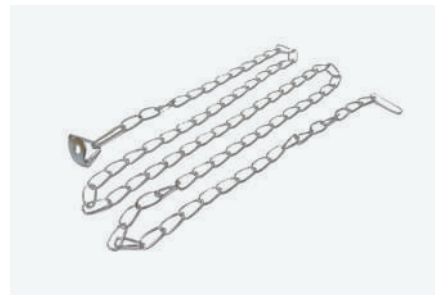

Brazo para luminario

Código	Descripción	Piezas
9402051	Brazo para luminario tipo estacionamiento	1



Luminario tipo estacionamiento de LED

Código	W	V	Hz	K	lm	Tipo de LED	Vida (horas)	Piezas
ARLED365	40	120-277	60	5 000	5 000	NICHIA	50 000	1

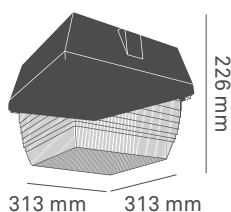
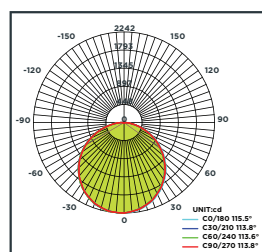

Lámparas de emergencia

Código	Descripción	V	Hz	Dimensiones	Duración	Piezas
				AxB (mm)	(minutos)	
9401576	Lámpara de emergencia	120-277	60	325x145	90	1

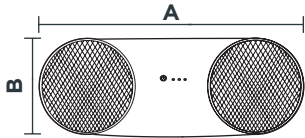

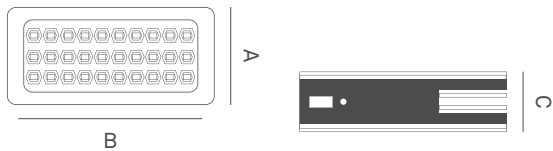

Lámparas de emergencia

Código	Descripción	W	V	Hz	lm	Dimensiones	Duración		Tiempo de recarga	Piezas
						AxBxC (mm)	En alta (minutos)	En baja (minutos)	(horas)	
9401515	Lámpara de emergencia 30 LEDs	3	127	60	150	64x220x45	180	360	15	1
9401520	Lámpara de emergencia 60 LEDs	6	127	60	300	60x393x43	180	360	20	1
9401580	Lámpara de emergencia 90 LEDs	9	127	60	450	79x625x70	180	360	20	1



Lámparas de señalización

Código	Color	Descripción	W	V	Hz	Duración (minutos)	Piezas
9401591		“Salida” color verde	3	120-277	60	120	1
9401592		“Salida” color rojo	3	120-277	60	120	1



Portalámpara tipo candil

Código	Material	W	Base	Piezas
9400120	Cerámica	660	E-12	50
9400125	Cerámica	660	E-14	50



Portalámpara tipo anuncio

Código	Material	W	Base	Piezas
9400130	Cerámica	660	E-26	240



Portalámpara base cuadrada

Código	Material	W	Base	Piezas
9400160	Cerámica	660	E-26	240

NOM



Portalámpara redonda 4"

Código	Material	W	Base	Piezas
9400140	Baquelita	660	E-26	240
9400150	Cerámica	660	E-26	50

NOM



Portalámpara tipo mogul

Código	Material	W	Base	Piezas
9400170	Cerámica	660	E-35	120

· Incluye cables para instalación.

NOM



Adaptador con portalámparas fluorescente

Código	W	Tubo	Piezas
9400998	660	T-5	100



NOM

Portalámparas fluorescente

Código	W	Tubo	Piezas
9400992	660	T-5	100
9400995	660	T-8	200



NOM

Portalámpara GU10

Código	W	Base	Piezas
9400110	50	GU10	50

· Incluye cables para instalación.



NOM

Portalámparas con sensor de movimiento

Código	Descripción	V	Hz	Base	Piezas
9402520	Portalámparas con sensor de movimiento	127	60	E-26	1



NOM



Sensor de movimiento

Código	Descripción	W	V	Hz	Piezas
9402510	Sensor de movimiento de techo	36	127	60	1
9402500	Sensor de movimiento de pared	85	127	60	1



NOM

Interruptor fotoeléctrico

Código	Descripción	V	Piezas
9402300	Interruptor fotoeléctrico	120-240	100



NOM



Base para fotocelda

Código	Descripción	V	Piezas
9402400	Base para fotocelda con ménsula	120-240	100

NOM

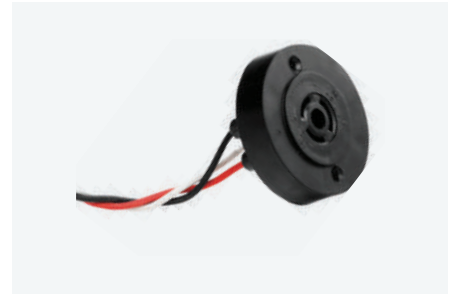

Interruptor fotoeléctrico

Código	Descripción	V	Piezas
9402360	Interruptor fotoeléctrico	127	100

NOM



Conectores IP-68

Código	Descripción	V	A	Piezas
9401010	Conector en "T"	450	24	50

